

# 133-WTR2-JA4

Wall Mounted 2-Valve Trim

For use with SS-506 concealed rough

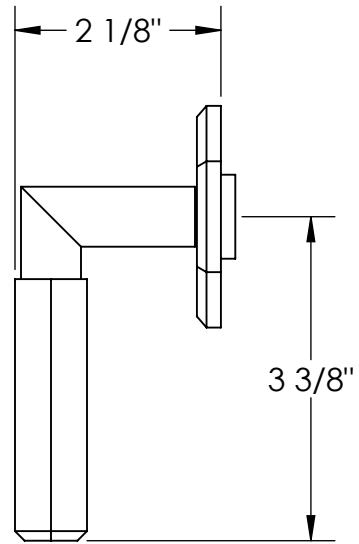
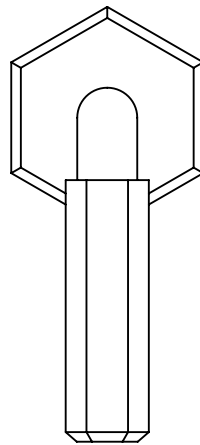
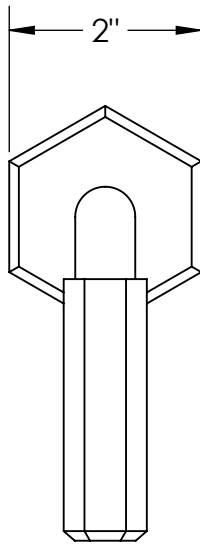
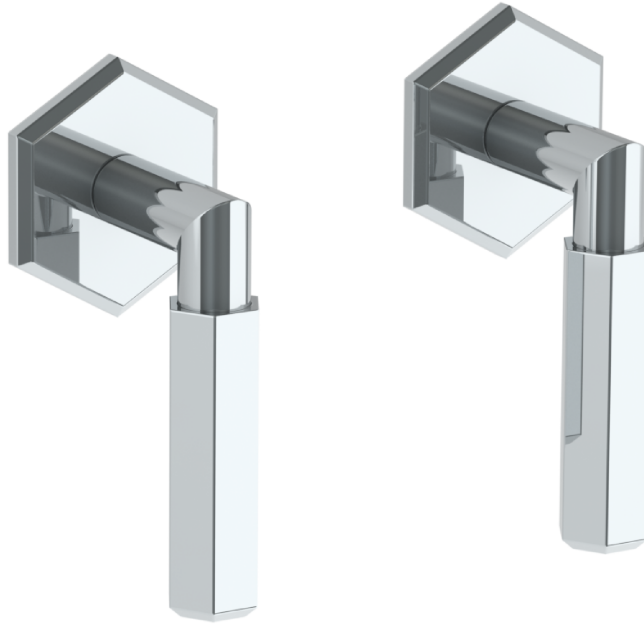

Meets the applicable requirements of ASME A112.18.1-2005/CSA B125.1-05, entitled "Plumbing Supply Fittings"