

# Schedule 40

## Innovator Plus® 940/941

Combines the Innovator® Overflow Assembly and the Perfect Fit® Drain Assembly

### Sturdy 1.5" Schedule 40 PVC or ABS Solvent-Weld Assembly

#### SPECIFICATIONS

#### FEATURES:

- Eliminates all screws
- Eliminates need for separate overflow test plug
- Eliminates leaks due to loose overflow attachment
- Hand-adjustable flange allows a tight-fitting overflow flange on a wide range of tub angles.
- Reversible tee and elbow for direct-drain application

#### APPROVALS (940/941 models):

- Manufactured in compliance with ASME A112.18.2-2005/CSA B125.2-2005.

#### PATENTS (Innovator®):

- See <http://watcomfg.com/Watco/patents/> for details

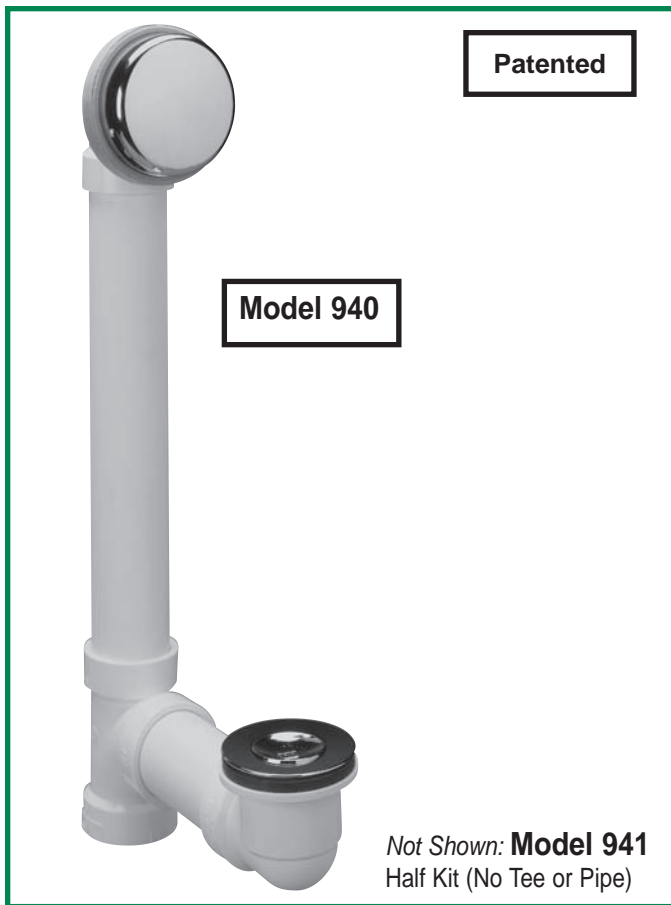

### Special Features of the 940:



Includes built-in test membrane

Easily remove membrane after test

Snap-on overflow plate. No screws



Drain Flange Gasket

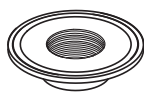

Perfect Fit Drain Flange



Perfect Fit Drain Elbow

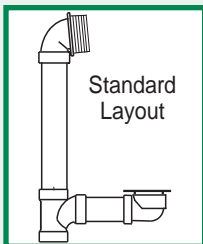

Standard Layout

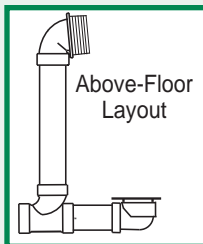

Above-Floor Layout

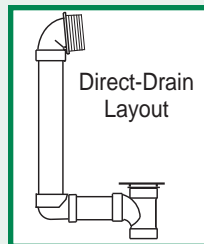

Direct-Drain Layout



For More Information Contact:  
**WATCO Manufacturing Company**  
 1220 South Powell Road  
 Independence, MO 64057-2724  
 Ph. 816-796-3900 • FAX 816-796-0875  
[www.watcomfg.com](http://www.watcomfg.com)

#### THREAD SIZE (Strainer Body and Drain Elbow):

- 1<sup>3</sup>/<sub>8</sub>" - 16 NPSM (Fine Thread)
- 1.625" Major Diameter (outside thread diameter)
- 16 threads per inch

#### PIPING:

- PVC
- ABS

#### ROUGH-IN (RI's) and STOPPER/FACEPLATE (SF's)

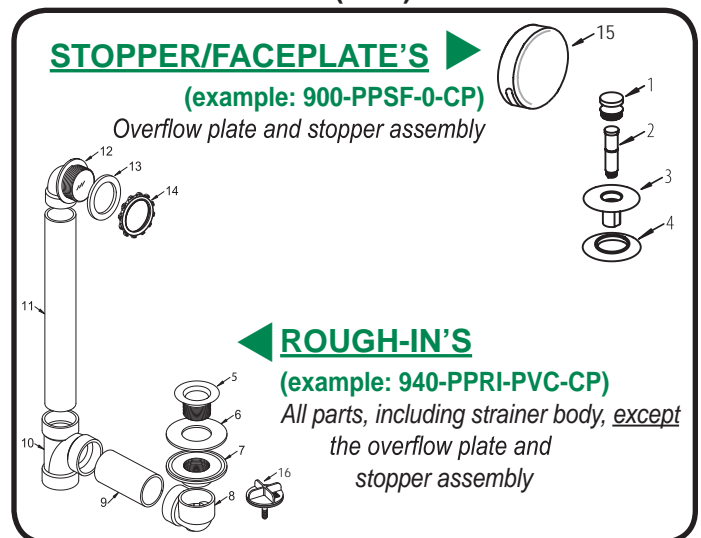

# 940/941 Series Parts List

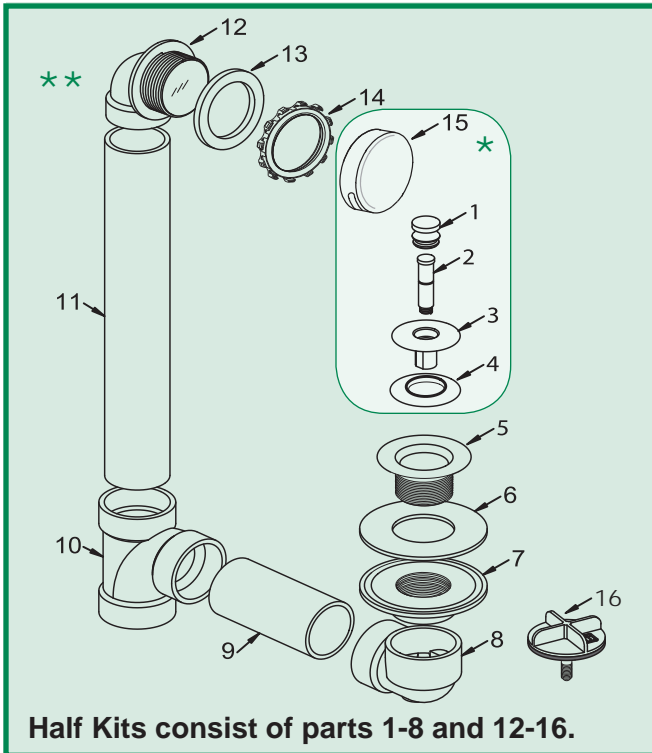

Half Kits consist of parts 1-8 and 12-16.

\* SF: (example: 900-PPSF) Parts #1 thru #4, and #15

## Item Part # Description

1. 01010CP ..... Knob, Brass
2. 11510..... Friction Ring (11505) and Post (11532)
3. 01013CP ..... Stopper, Brass
4. 11507 ..... Seal, 1/16" dia.
5. 01022CP ..... Strainer Body, 1.625" - 16 - 1.25", Metal
6. 10693..... Drain Flange Gasket, Perfect Fit®
7. 11022 ..... Drain Flange, Perfect Fit®, ABS  
14022 ..... Drain Flange, Perfect Fit®, PVC
8. 11023 ..... Drain/Overflow Elbow, Perfect Fit®, ABS  
14023 ..... Drain/Overflow Elbow, Perfect Fit®, PVC
9. SCHABS-4.625... Pipe, Schedule 40, ABS, 1.5" x 4.625"  
SCHPVC-4.625... Pipe, Schedule 40, PVC, 1.5" x 4.625"
10. 14011..... Sanitary Tee, Schedule 40, ABS  
14010 ..... Sanitary Tee, Schedule 40, PVC
11. SCHABS-11.75... Pipe, Schedule 40, ABS, 1.5" x 11.75"  
SCHPVC-11.75... Pipe, Schedule 40, PVC, 1.5" x 11.75"
12. 11020 ..... Innovator® Overflow Ell, Schedule 40, ABS  
14020 ..... Innovator® Overflow Ell, Schedule 40, PVC
13. 10675 ..... Overflow Ell Washer, Foam
14. 11121 ..... ABS Retainer Star Nut for Innovator®
15. 01004CP ..... Overflow Plate for Innovator®
16. 11575..... Test Plug with O-Ring-type Gasket

\*\* RI: (example: 940-PPRI) Parts #5 thru #14, and #16

## OPTIONAL TUB CLOSURES FOR 940/941-SERIES BATH WASTES (PUSH PULL® ALSO SHOWN ABOVE)

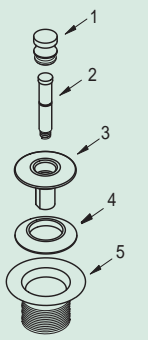
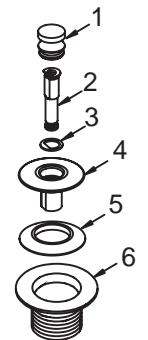
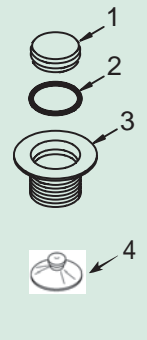
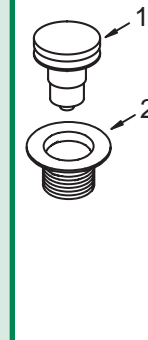
 PUSH PULL® Fine Thread	 LIFT & TURN Fine Thread	 PRESFLO® Fine Thread	 FOOT ACTUATED Fine Thread
1. 01010CP 01010_*	1. 01010CP 01010_*	1. 11155CP 11155_*	1. 38412CP 38412_*
2. 11510	2. 11079	2. 11131	2. 11491CP 01022_*
3. 01013CP 01013_*	3. 11088	3. 11070CP 11070_*	
4. 11507	4. 11290CP 01013_*	4. 96039: Suction Cup for removing stopper	
5. 01022CP 01022_*	5. 11507		
	6. 01022CP 01022_*		

U.S. Pat. No. 4,720,877      U.S. Pat. No. 5,758,368      U.S. Pat. No. 4,457,030

\*If finish other than Chrome is desired, please use this part number and indicate desired finish.

## Finishes Available in the 940/941 Series:

Tub Closures:	PUSH PULL®	LIFT & TURN	PRESFLO®	FOOT ACT.
CP - Chrome Plated	●	●	●	●
AB - Antique Brass				
AP - Aged Pewter	●	●	●	
BB - Brushed Bronze	●	●	●	
BN - Brushed Nickel	●	●	●	●
BO - Bone	●	●		
BS - Biscuit	●	●		
BZ - Oil-Rubbed Bronze	●	●	●	●
CB - Chrome Brushed	●	●	●	
NP - Nickel Polished	●	●	●	●
PB - Polished Brass	●	●	●	●
	●	●	●	
WH - White	●			
WI - Wrought Iron	●	●	●	



ADA

PRESFLO® (PF)  
Foot Actuated (FA) only

See current price list for complete item numbers and available options.

When ordering, please specify complete item number and any applicable option codes.