

CODE NUMBER

12051301

DESCRIPTION

SU-1205 Urinal and ROYAL 186 ESS Flushometer.

COMPONENTS

- Flushometer: Code 3452674
- Urinal: Code 1101205

DETAILS

- Flush Volume: 0.5 gpf (1.9 Lpf)
- Nominal Dimensions: 14 ½" x 20 ¾" x 25 ¼" (368 x 527 x 641mm)

FLUSHOMETER FEATURES

Quiet, Exposed, Dual Filtered Diaphragm Assembly, Chrome Plated Urinal

- Sweat Solder Adapter w/Cover Tube and Cast Wall Flange w/Set Screw
- OPTIMA® EL-1500 Self-Adaptive Infrared Sensor with Indicator Light
- Non-Hold-Open Integral Solenoid Operator, Fixed Metering Bypass and No External Volume Adjustment to Ensure Water Conservation
- High Back Pressure Vacuum Breaker Flush Connection with One-Piece Bottom Hex Coupling Nut, Spud Coupling and Flange for ¾" Top Spud
- Stop Seat and Vacuum Breaker molded from PERMEX® Rubber Compound for Chloramine Resistance
- ¾" I.P.S. Screwdriver Bak-Chek® Angle Stop with Vandal Resistant Stop Cap
- Infrared Sensor with Multiple-focused, Lobular Sensing Fields for high and low target detection

FIXTURE FEATURES

- Wall hung vitreous top spud china
- Large footprint to cover old caulk lines
- Washdown flushing action
- ¾" I.P.S. top spud inlet
- 2" NPT outlet flange
- All mounting hardware included
- Integral flushing rim
- 100% factory flush tested
- Carrier not included



COMPLIANCES & CERTIFICATIONS



(ADA Compliant, cUPC Green Certified, UL Certified, WaterSense Listed, BAA Compliant, Satisfies LEED Credits)

DOWNLOADS

- [Retrofit Urinal Installation Instructions](#)
- [SS/ST/SU/WETS/WEUS Fixtures Repair and Maintenance Guide](#)
- [Additional Downloads](#)

NOTES

All information contained within this document subject to change without notice.

ROUGH-IN

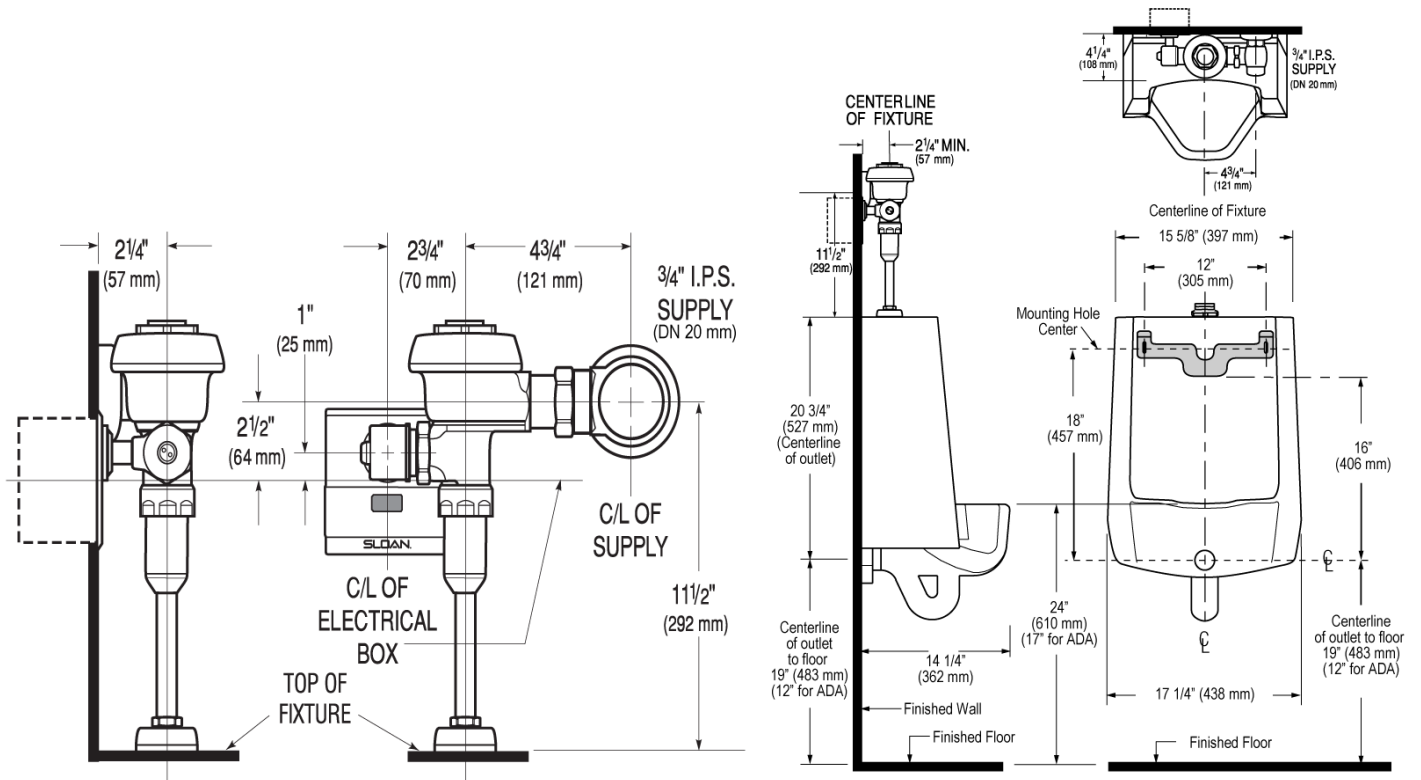

Sloan 10500 Seymour Ave, Franklin Park, IL 60131
Phone: 800.982.5839 • Fax: 800.447.8329 • sloan.com