

Metro

MET

LEG SYSTEM CONFIGURATIONS

1.0" DIAMETER TUBING with 5/8" diameter crossbars

Order #:

Finish:

Inspector:

2-LEG
 Model:
LS21MET

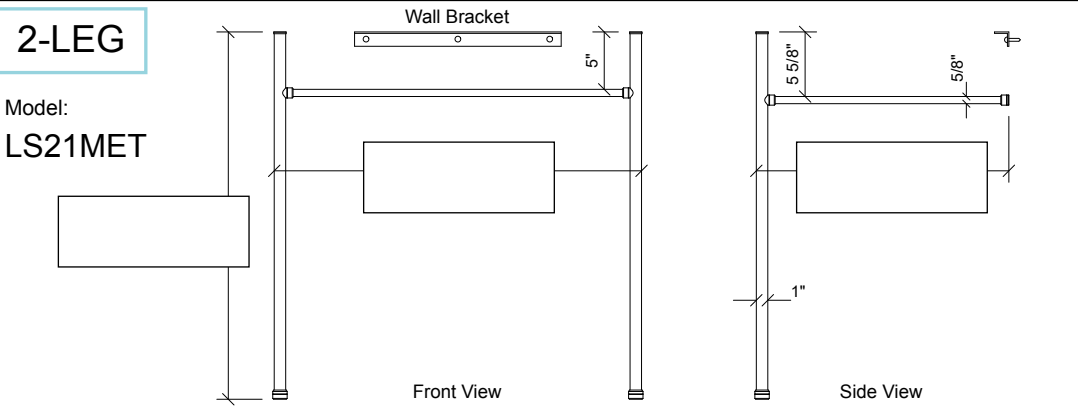

3-LEG
 Model:
LS31MET

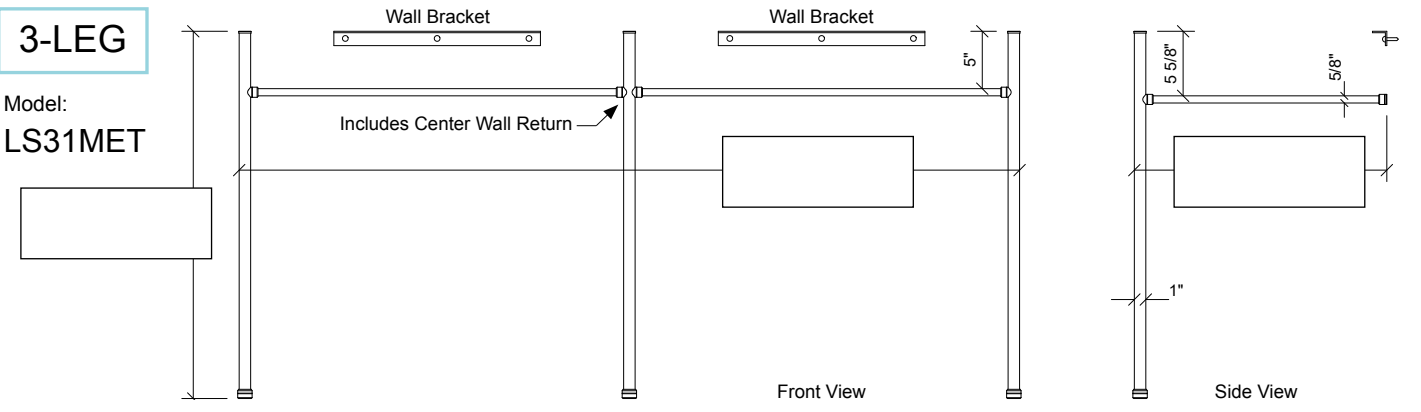

4-LEG
 Model:
LS41MET

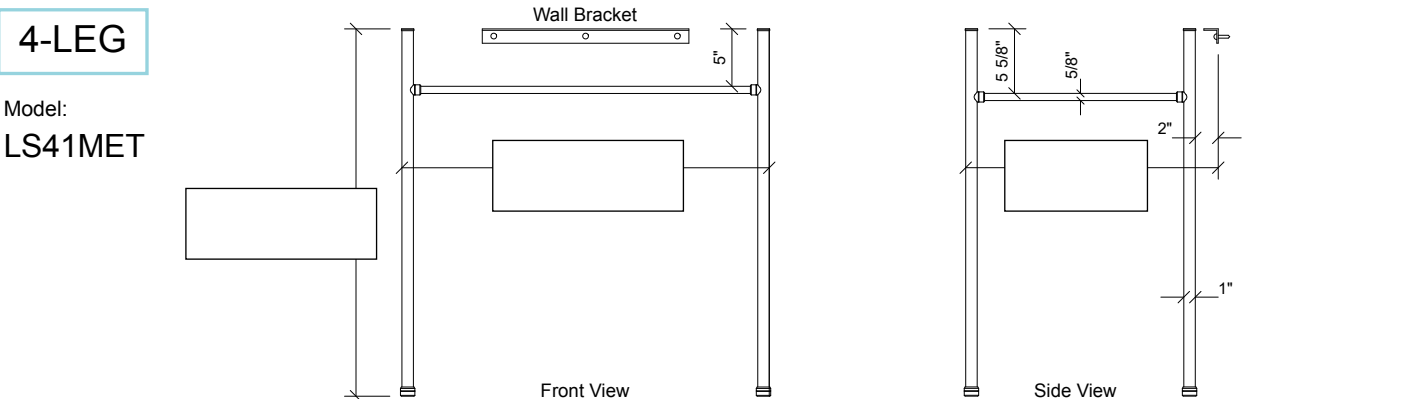

5-LEG
 Model:
LS51MET

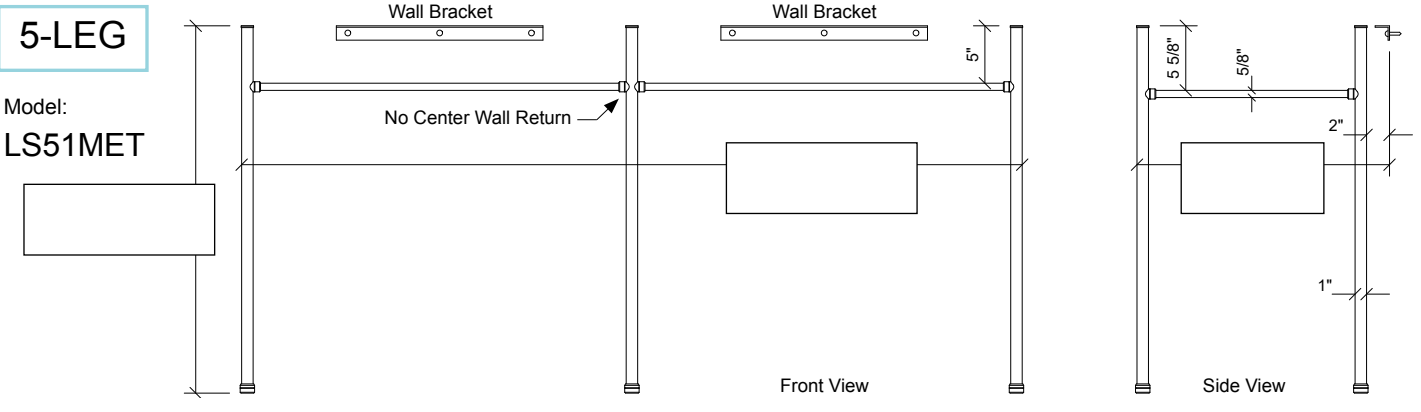

rev: 020720

Metro



LEG SYSTEM ASSEMBLY

1.0" DIAMETER TUBING with 5/8" diameter crossbars

1.5" DIAMETER TUBING with 1.0" diameter crossbars

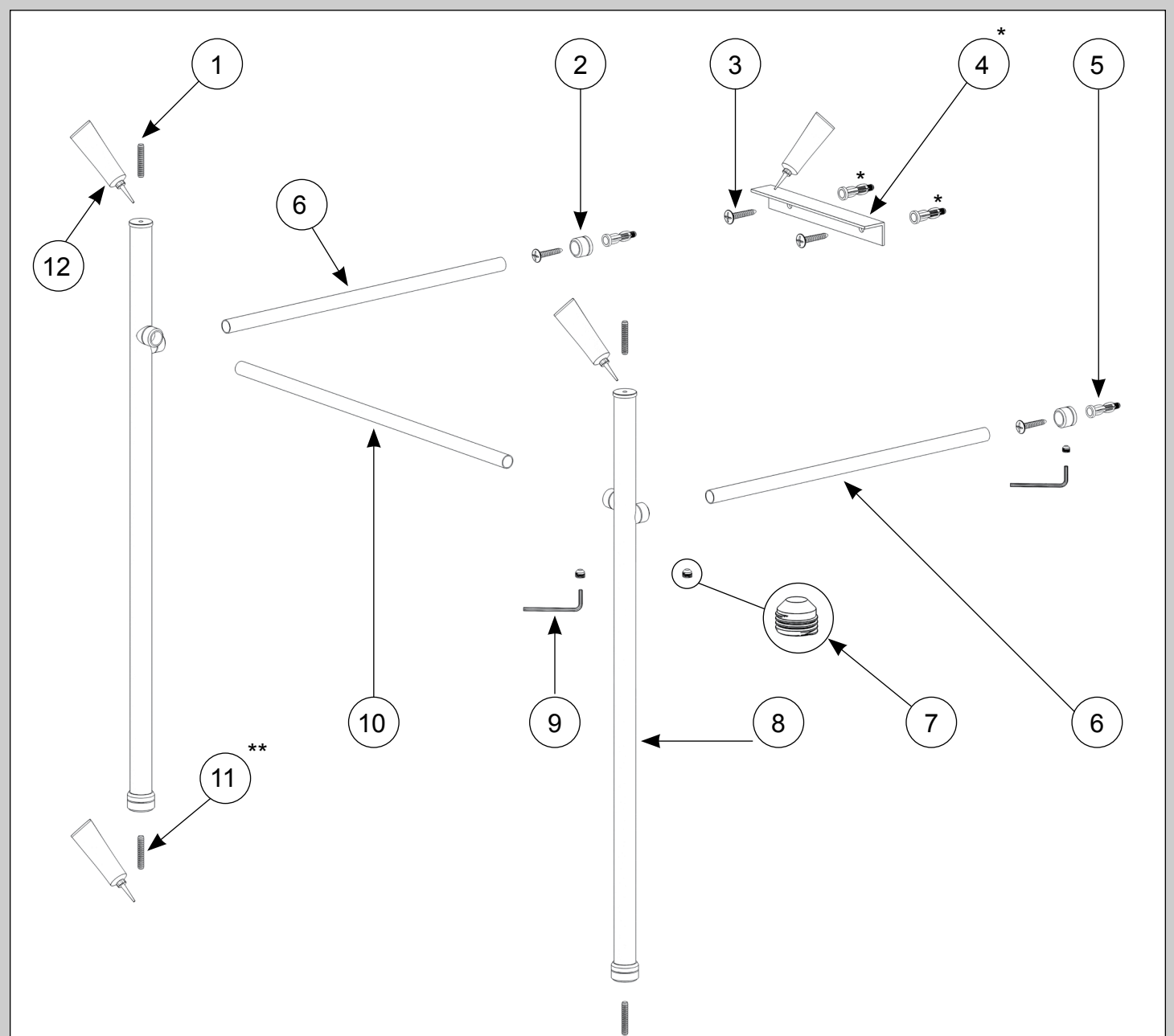

- | | |
|---------------------|------------------------------|
| 1. Counter Pin | 7. Set Screw |
| 2. Wall Flange | 8. Leg Assembly |
| 3. Structural Screw | 9. Hex Wrench |
| 4. Wall Bracket* | 10. Front Crossbar |
| 5. Wall Anchor | 11. Floor Pin** (same as #1) |
| 6. Wall Return | 12. Silicone Adhesive |

* It is recommended that load bearing Wall Bracket (#4) be screwed into framing or blocking.
see: Wall Bracket Installation page

** Floor Pins (#11) MUST engage 1/4" diameter holes drilled into flooring

rev: 020720

Metro

MET

LEG SYSTEM INSTALLATION INSTRUCTIONS

1.0" DIAMETER TUBING with 5/8" diameter crossbars

1.5" DIAMETER TUBING with 1.0" diameter crossbars

INSTALLATION INSTRUCTIONS

- Determine that you have received the correct product before unpacking and unwrapping the leg system components.
- The leg system components must be protected from abrasion and scratching during installation. Use padding on the floor to protect your console during layout and assembly.
- The Metro style may be field cut to reduce width, depth, and height.
- Verticals must be plumb and horizontals must be level. Wall Returns and Shelf Supports must be parallel, and square to the Horizontal Crossbar. Leg heights may need to be shimmed to achieve a level counter top.
- Leg assemblies must be positioned so that the set screw holes face toward the back wall and Wall Flanges must be rotated so that the set screw holes are not visible from a standing position in front of the vanity.
- Wall bracket must be secured solidly to the wall to bear the weight of the counter top.
- Legs **MUST** be pinned to the floor to prevent lateral movement.
- The counter top must be attached to the tops of the legs and the wall bracket with silicone adhesive. Confirm that the installation is correct and complete and that the shelf, if included, fits properly before permanently gluing the counter top into place.

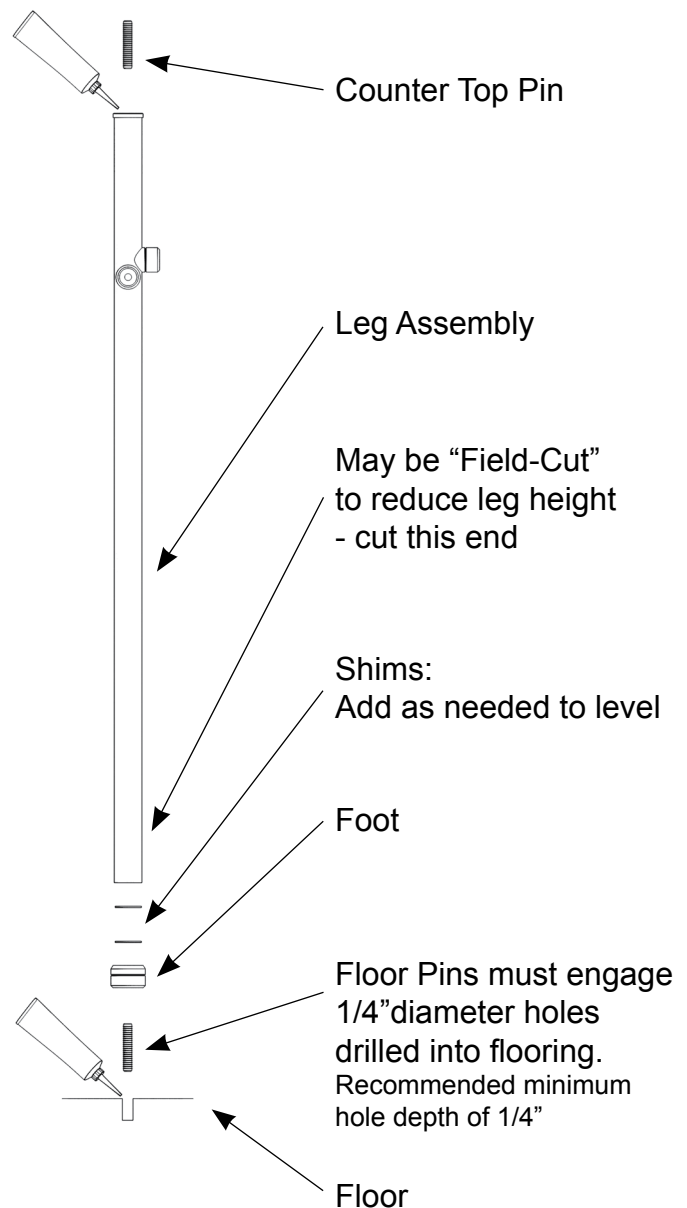

SEE ADDITIONAL PAGES FOR INSTRUCTIONS SPECIFIC TO INCLUDED OPTIONS.

rev. 020720



WALL BRACKET INSTALLATION INSTRUCTIONS

PROPER INSTALLATION OF THE PROVIDED ALUMINUM ANGLE WALL BRACKET(S) IS CRITICALLY IMPORTANT TO THE STRUCTURAL INTEGRITY OF OUR LEG SYSTEMS.

- Fastening the wall bracket to solid wood blocking in the wall is highly recommended. A MINIMUM OF (3) FASTENERS SHOULD BE USED. If solid blocking is not available, fasten bracket to stud framing in the wall. Use the included fasteners or fasteners of the appropriate length to engage sufficiently with the framing.
- The bracket has pre-drilled holes for easy fastening. However if the pre-drilled holes do not align with the stud framing in the wall, additional holes must be drilled into the bracket at the stud location(s).
- The wall bracket must be carefully positioned such that the top surface of the bracket is perfectly level with the top of ALL legs and risers.
- A generous bead of silicone (adhesive) must be applied to the top of the wall bracket and the tops of the legs (and rear risers if applicable) in order to secure the sink top.

TILE WALL / DRYWALL APPLICATIONS - Standard Wall Bracket

- If the stud locations can be determined, drill holes in the tile at these locations and use #12 screws of the appropriate length to engage with the framing at least 1-1/2".
- For non-stud locations, drill 9/32" holes into the tile and use the provided red anchors and #12 screws.

* Standard Wall Bracket

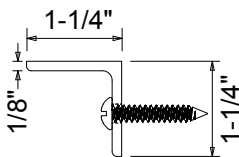

** Heavy Duty Wall Bracket

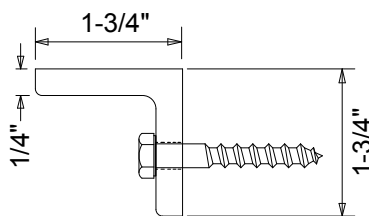

Bears the primary load of the counter.

