

Features

- Solid brass construction
- 8.69" (22.0 cm) spout length
- 1/2" NPT spout inlet fitting
- Rough valve incorporates a brass valve body assembly
- Rough valve incorporates quarter-turn washerless ceramic disc valve cartridges
- Intended for use with Newport Brass rough valve as specified (Required Accessory)
- ADA Compliant

Wall-Mounted Tub Trim

3-3335



Codes / Standards Compliance

Meets or exceeds the following at date of manufacture:

- ASME A112.18.1/CSA B125.1
- IAMPO/cUPC
- IPC
- ADA & ICC/ANSI A117.1
- All applicable US Federal and State material regulations



Colors / Finishes

- 10B: Oil Rubbed Bronze
- 15: Polished Nickel
- 15S: Satin Nickel - PVD
- 26: Polished Chrome
- Other: Refer to the Newport Brass catalog for additional color/finish options.

Specified Model

Model	Description	Colors Finishes
3-3335	Wall-Mounted Tub Trim	<input type="checkbox"/> 10B <input type="checkbox"/> 15 <input type="checkbox"/> 15S <input type="checkbox"/> 26 <input type="checkbox"/> Other

Required Accessory

Application	Wall Tub Rough Valve
Description	2-Cartridge Assembly
Inlet/Outlet Size	1/2"
Part Number	1-500U
Image	

Product Specification

The Wall-Mounted Tub Trim shall be made of solid brass construction. Wall-Mounted Tub Trim shall include cross handles and a 8.69" (22.0 cm) tub spout that incorporates a 1/2" NPT inlet fitting. Wall-Mounted Tub Trim shall be Newport Brass Model 3-3335/____ and Newport Brass rough valve shall be 1-500U.

3-3335

Product Dimensions are provided for reference only. For specific product installation guidelines, please reference the Installation Instructions of the product being installed.

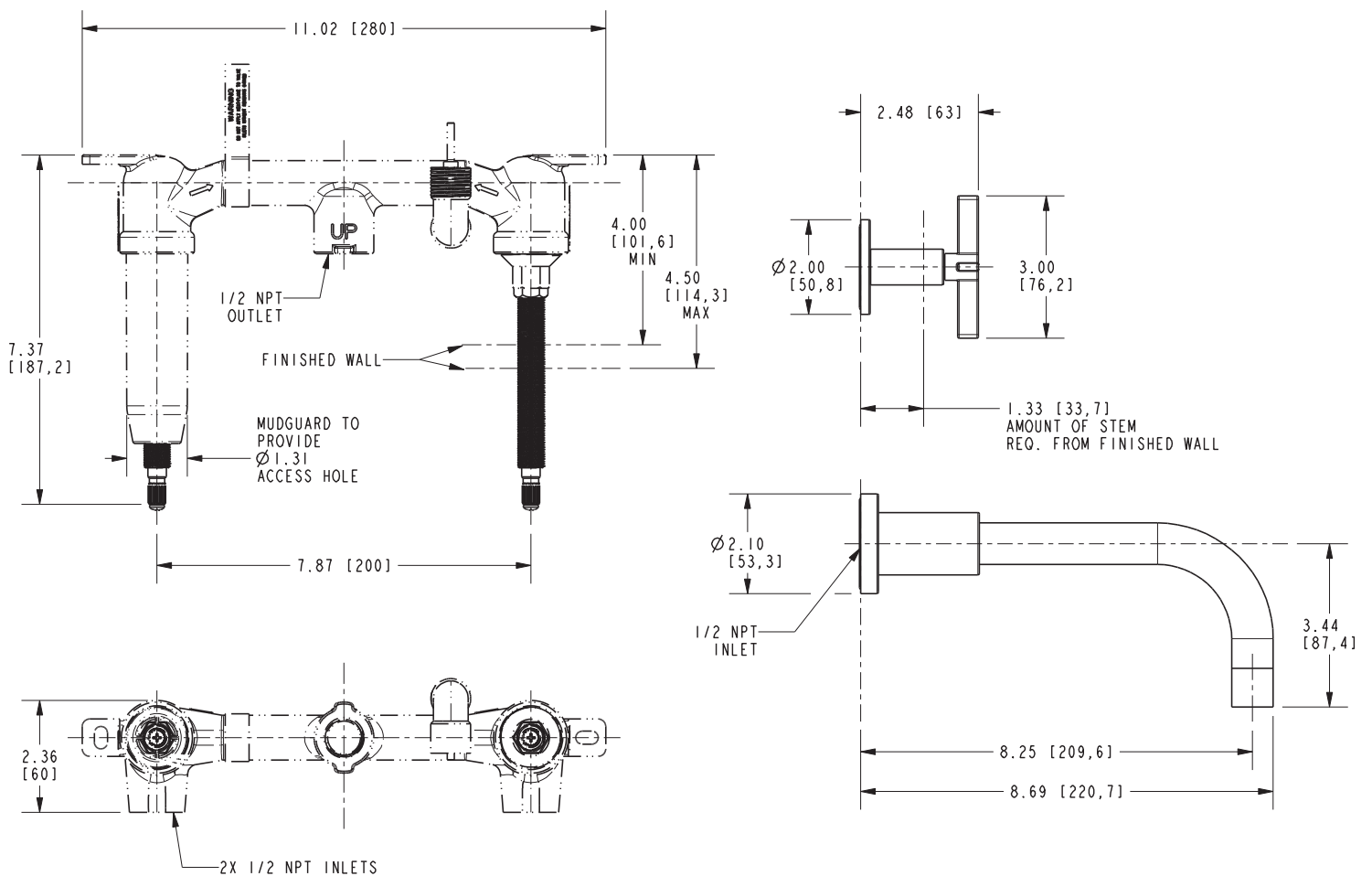

Tolmin Wall-Mounted Tub Trim 3-3335