

760 NYREN™







Elongated Front, Bidet, Vitreous China, One-Piece Tankless Toilet



FEATURES

- Compact, sleek one-piece smart toilet with integrated personal cleansing system
- High efficiency dual flush water consumption (1.6 gpf / 6.0 lpf full flush, 1.1 gpf / 4.2 lpf half flush)
- Elongated front, skirted bowl conceals trapway providing a sleek, easy-to-clean design
- Power assist double siphon flush action clears and rinses the bowl twice with every full flush
- Effortlessly operate the toilet and seat using the manual knob or the wireless remote control (hanger and mounting hardware included)
- Touchless flush automatically activates after use
- Multi-function electronic bidet seat
 - Heated seat (6 temperature levels, instant activation, auto shut-off)
 - Bidet washing (5 spray positions, 6 temperature levels, 3 pressure settings, stationary & motion wash modes)
 - Air dryer (6 temperature levels)
 - Manual control and automatic cycle choices
 - Intelligent LED night light
 - Antibacterial deodorization
 - Slow close, prevents slamming
 - Capacitive sensor detects when a user is present
- Energy saver mode
- 12" rough-in
- Complete kit includes supply line, supply valve, sealing gasket and seat
- Electrical outlet required
- Three-year limited warranty on all components
- Available in White



MODEL 760	  
Toilet seat included	  

COMPONENTS



MODEL #	DESCRIPTION	CODES/STANDARDS
760	Elongated front, tankless one-piece toilet with integrated bidet. Includes toilet seat, supply line, supply valve and sealing gasket.	 

760 NYREN™



Elongated Front, Bidet, Vitreous China, One-Piece Tankless Toilet

SPECIFICATIONS

MODEL #	DESCRIPTION	CODES/STANDARDS
760	Elongated front, Dual Flush (1.6 gpf/6.0 lpf and 1.1 gpf/4.2 lpf) one-piece smart toilet	 

MATERIAL	Vitreous China
WATER PRESSURE REQUIREMENT	0.09 MPa or more
FLUSH SYSTEM	Power assist double siphon jet
WATER USAGE	1.6 gpf / 6.0 lpf and 1.1 gpf / 4.2 lpf
WATER SURFACE AREA	5.8' x 7.5'
ROUGH-IN	12'
MaP RATING	600 grams

TRAP DIAMETER	1.77'
TRAP SEAL	2.6'
VOLTAGE	110V-120V, 50/60Hz
WATERPROOF RATING	IPX4
SHIPPING WEIGHT	Model 760 - 97 lbs. (44 kg)
WARRANTY	Limited Three-Year

TECHNICAL INFORMATION

Note: these dimensions are nominal and subject to change without notice.

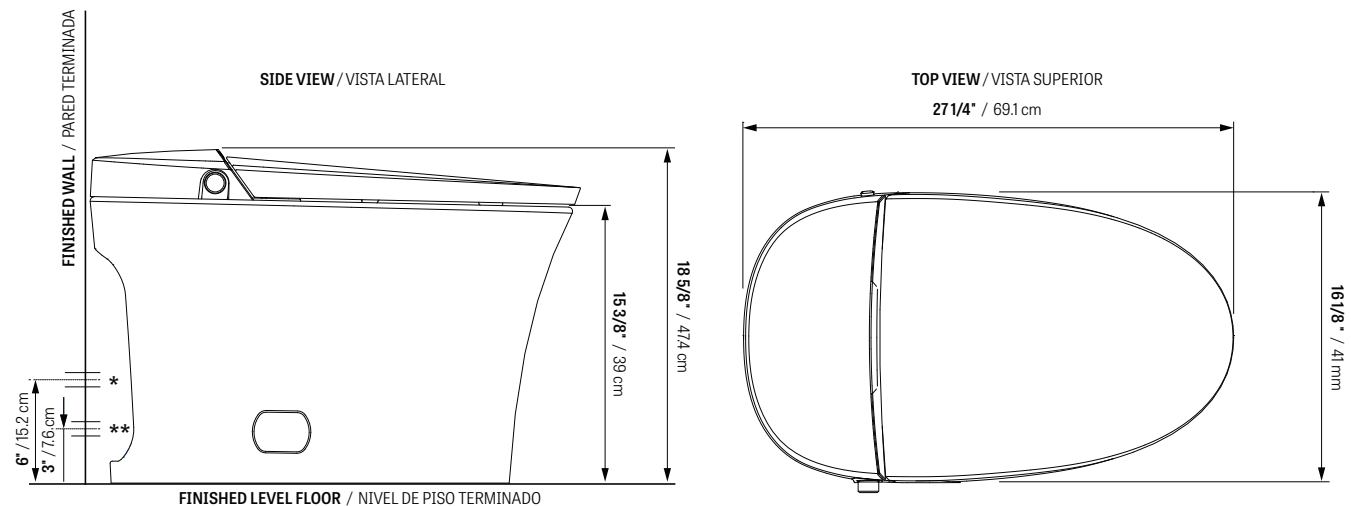

* External installation of water inlet tube for the toilet.

** Internal installation of water inlet tube for the toilet.

Fixture performance and specifications meet or exceed ASME A112.19.2/CSA B45.1 standards, and other state and local codes.