



Model: **14-814L-L-\_\_** Item #: \_\_\_\_\_ Date: \_\_\_\_\_  
 Project: \_\_\_\_\_ Qty: \_\_\_\_\_ Approved by: \_\_\_\_\_

## 8" Wall Mount with 14" Swing Spout, Lever Handles

Royal Series Plumbing



### SPECIFICATIONS

Water Inlet	1/2" NPT
Temp. Range	40°F - 180°F
Rough In	7/8" Round Holes on 8" Center
Material	Chrome Plated Brass
Weight	5 lbs.

### PRODUCT COMPLIANCE

- ASME A112.18.1-2011/CSA B125.1-11
- NSF-61
- NSF/ANSI 372
- Meets ANSI A117.1 (ADA)
- California Proposition 65



### DESCRIPTION

- 8" Center Wall Mount Faucet with 14" Swing Spout, Lever Handles, Polished Chrome Finish

### STANDARD FEATURES

- 1/4 Turn High Performance Ceramic Cartridge Valves with Integral Check
- Durable Full Range Swing Spout with Double O-ring Construction
- Lever Handles
- Warranty: 3 Years

### AERATORS

Standard Aerator	Suffix
<input type="checkbox"/> 0.20 GPM Aerator	E1
<input type="checkbox"/> 0.50 GPM Aerator	E2
<input type="checkbox"/> 1.00 GPM Aerator	E3
<input type="checkbox"/> 1.50 GPM Aerator	E4
<input type="checkbox"/> 1.80 GPM Aerator	E5
<input type="checkbox"/> 2.20 GPM Aerator	E6

Vandal Resistant Aerator	Suffix
<input type="checkbox"/> 0.35 GPM Aerator	G1
<input type="checkbox"/> 0.50 GPM Aerator	G2
<input type="checkbox"/> 1.00 GPM Aerator	G3
<input type="checkbox"/> 1.50 GPM Aerator	G4

Laminar Flow Outlet	Suffix
<input type="checkbox"/> 0.50 GPM Outlet	F1
<input type="checkbox"/> 1.50 GPM Outlet	F2

Vandal Resistant Laminar Flow Outlet	Suffix
<input type="checkbox"/> 0.35 GPM Outlet	H1
<input type="checkbox"/> 0.50 GPM Outlet	H2
<input type="checkbox"/> 1.00 GPM Outlet	H3
<input type="checkbox"/> 1.50 GPM Outlet	H4

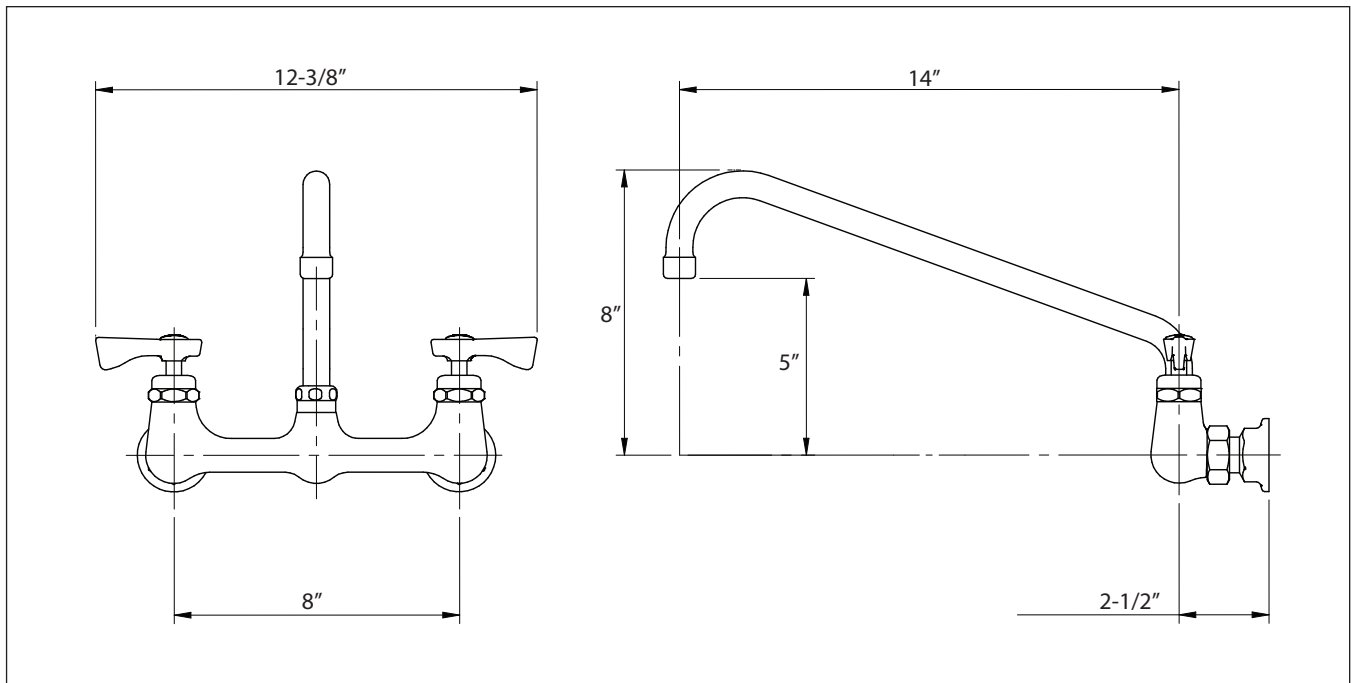

**WARNING:** Plumbing connections should be made by qualified personnel who will observe all applicable plumbing, sanitary and safety codes.

**WARNING:** This product can expose you to chemicals including lead and lead compounds which are known to the State of California to cause cancer and birth defects or other reproductive harm. For more information go to [www.P65Warnings.ca.gov](http://www.P65Warnings.ca.gov).

Krowne Metal Corporation • 100 Haul Rd. Wayne, NJ 07470 • Toll Free: (800) 631-0442 • Fax: (973) 872-1129 • [sales@krowne.com](mailto:sales@krowne.com) • [krowne.com](http://krowne.com)

Due to our commitment to continued product improvement, specifications are subject to change without notice.

Rev. 5/2020 • No. 14-814L-L-\_\_