

Features

- For baths 15" (381 mm) to 21" (533 mm) deep from the center of the bath overflow outlet to the center of the bath drain outlet.
- 30" (762 mm) length external cable.
- Flexible overflow joint conforms to various bath angles.
- Rotary or push handle controls and pop-up drain stopper (sold separately).
- No internal linkages to minimize the potential for clogging.
- Includes tee, drain ell, and overflow ell with attached 1-1/2" OD pipe.
- Flexible overflow neck for easy installation to fit various bath angles.

Material

- Solid-brass construction for durability and reliability.
- 17-gauge brass drain pipe.

Installation

- Above- or through-floor installation.
- Can be installed and tested without required trim kit.

Required Products/Accessories

K-T37391 Rotary-turn bath drain trim

or

K-T37392 Rotary-turn bath drain trim

or

K-T37393 Traditional rotary-turn bath drain trim

or

K-T37395 Bath drain trim

or

K-T37396 Traditional push-button bath drain trim

Recommended Products/Accessories

K-23726 Drain treatment

K-23723 Faucet cleaner



Codes/Standards

ASME A112.18.2/CSA B125.2

KOHLER® One-Year Limited Warranty

See website for detailed warranty information.

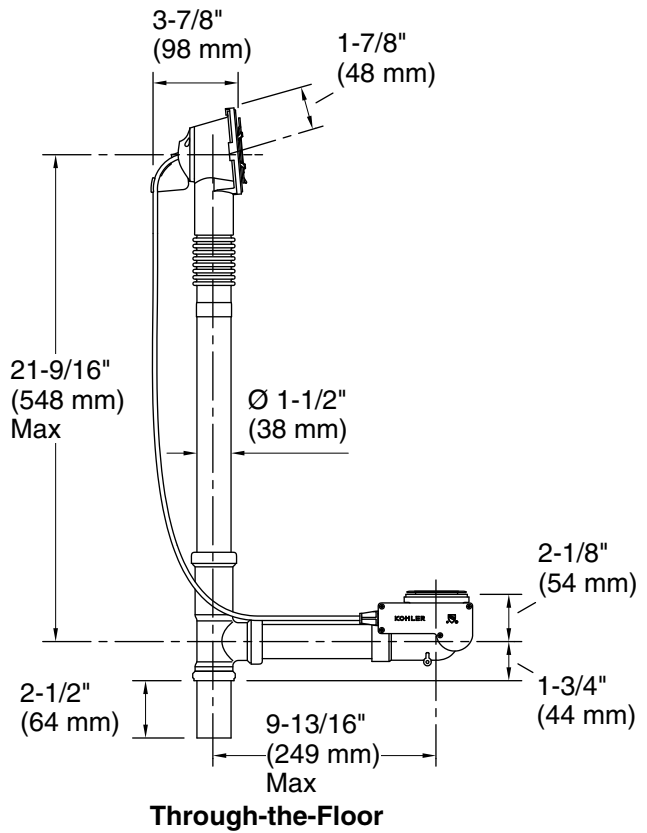
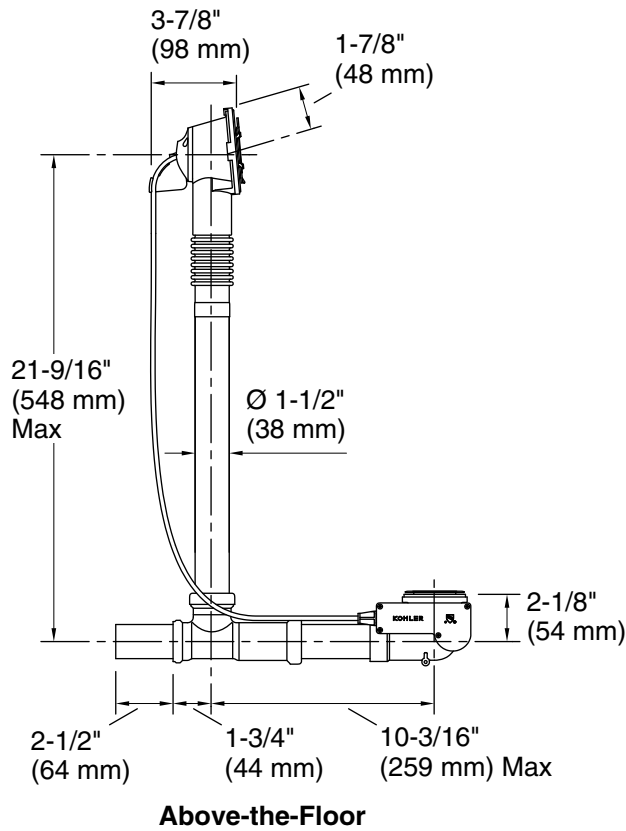

Technical Information

All product dimensions are nominal.

Drain included: Yes