

### Features

- Single-speed whirlpool offers performance and value, with 6 fully adjustable jets.
- Hydromassage flow and direction can be controlled at each jet.
- Built-in heater.
- Generous 6-foot length provides an incredibly spacious bathing area.
- Hourglass shape adds style and elegance to your bathroom.
- Integral flange helps prevent water from seeping behind wall and simplifies alcove installation.
- Textured bottom surface
- Left-hand drain.

### Material

- Acrylic

### Hydrotherapy

- Whirlpool

### Installation

- Three-wall alcove.

### Additional Hydrotherapy Options

- Soaking Bath - 1259-L
- Soaking Bath + Bask heated surface - 1259-LW
- BubbleMassage air bath - 1257-GLF
- VibrAcoustic - 1257-VBL
- VibrAcoustic + Bask heated surface - 1257-VBLW
- Whirlpool - 1257-L
- Whirlpool + heater - 1257-LH
- Whirlpool + Bask heated surface - 1257-LW

### Recommended Products/Accessories

K-1283 Removable Apron  
K-1491 Bath/Whirlpool Pillow  
K-7166-AF Bath Drain  
K-24916 Wireless Music Kit  
K-7213 27" Cable Bath Drain  
K-7214 27" Cable Bath Drain  
K-7259 Clearflo Bath Drain



### Codes/Standards





ASME A112.19.7/CSA B45.10  
CSA B45.5/IAPMO Z124  
ASTM E162  
ASTM E662  
UL 1795

**KOHLER® Plastic Baths and Receptors  
Lifetime Limited Warranty  
KOHLER® Hydrotherapy Components  
Five-Year Limited Warranty**

See website for detailed warranty information.

### Available Colors/Finishes

*Color tiles intended for reference only.*

Color	Code	Description
	0	White
	96	Biscuit
	47	Almond
	NY	Dune
	G9	Sandbar

Pump/Control Access (If Apron Is Not Used):  
20" (508 mm) W x 15" (381 mm) H

No change in measurements if connected with  
drain illustrated. (K-11677)

□ Recommended Faucet Location

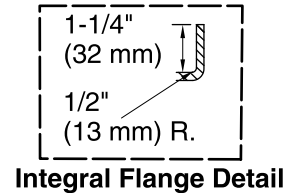
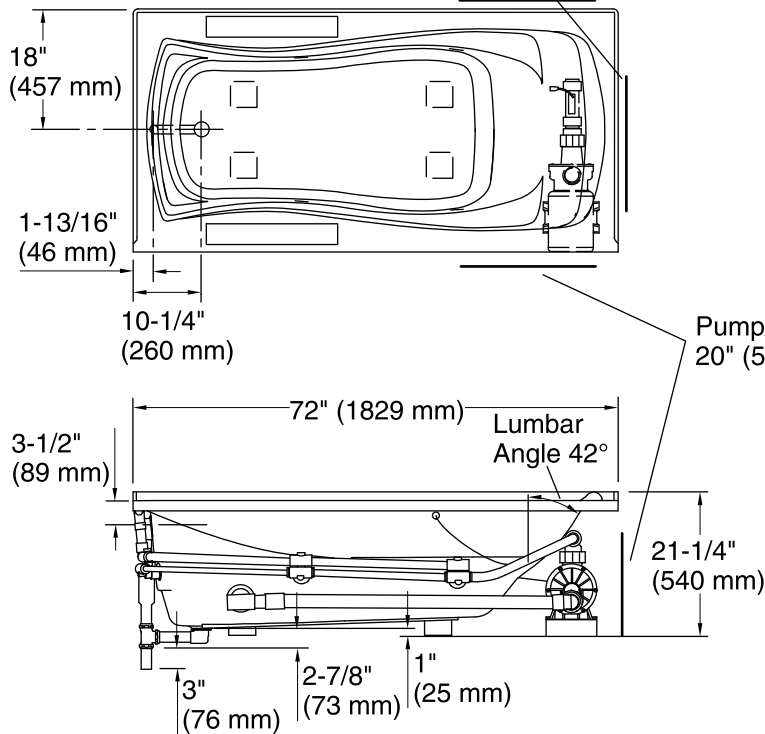

Pump/Control Access (If Apron Is Not Used):  
20" (508 mm) W x 15" (381 mm) H

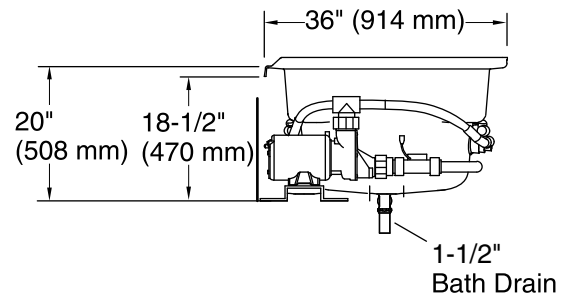

### Required Electrical Service

Two dedicated circuits required, protected with Class A Ground-Fault Circuit-Interrupter (GFCI). Outside North America, this device may be known as a Residual Current Device (RCD).

Pump: 120 V, 15 A, 60 Hz  
Heater: 120 V, 15 A, 60 Hz

### Technical Information

All product dimensions are nominal.

Installation: Three-wall alcove  
Drain location: Left  
Basin area, bottom: 50" x 24" (1270 mm x 610 mm)  
Basin area, top: 65" x 27" (1651 mm x 686 mm)  
Weight: 115 lbs (52.2 kg)  
Minimum floor load: 41 lbs/ft<sup>2</sup> (200.2 kg/m<sup>2</sup>)  
Water depth: 14" (356 mm)  
Water capacity: 72 gal (272.5 L)  
Electrical component rating: Pump: 120 V, 7.5 A, 60 Hz  
Heater: 120 V, 12.5 A, 60 Hz, 1500 W  
Pump speed: Single  
Minimum flat for door: 2-1/8" (54 mm)

### Notes

Measure your actual product for rough-in details. Install this product according to the installation instructions.

The hot water supply should be 70% of the capacity of the bath or greater. Installations will vary.

Provide one grounded electrical outlet within 24" (610 mm) of each component.

If installing a rim-mount faucet, make sure there is no interference above or below the deck before drilling any holes.