

JASON[®]

HYDROTHERAPY

8328 MacArthur Dr. • North Little Rock, AR 72118
 501.771.4477 • Fax: 501.771.2333
 Customer Service: 800.255.5766
 www.jasoninternational.com

Designer Collection Specifications

KT553

Air-Whirlpool

Blower Must Be Remote Mounted

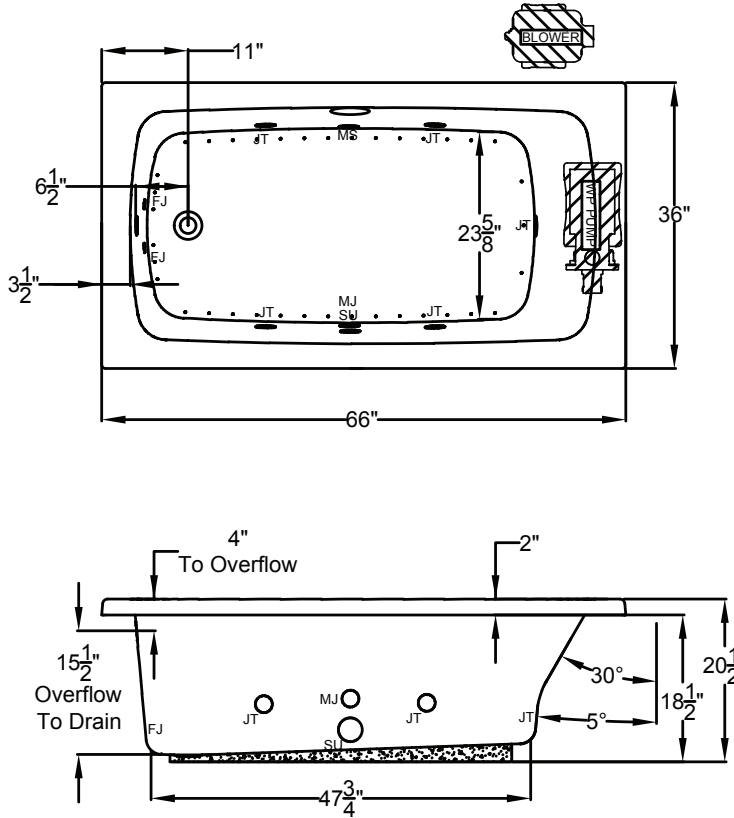

Patents received or pending.



Note: Dimensional Tolerances: ±1/4"

Drop-in-Hole Size:	64" x 34"
Operating Capacity:	48 Gal.
Overflow Capacity:	75 Gal.
Floor Loading / sq.ft.:	54.2 lbs.
Carton Weight:	165 lbs.
Cube:	34.3 ft. ³

REMOTE MOUNTING THE BLOWER:
 If an extension cord is required
 use a minimum 16 AWG cord
 with a maximum of 20ft length

Construction: Fiberglass reinforced acrylic bath with Level Form™ full-support base.

We provide products listed with Intertek ETL SEMKO (Edison Testing Laboratories) U.S. and Canadian and with International Association of Plumbing and Mechanical Officials (IAPMO). Consult factory with your listing requirements.

Standard		A 120V system that includes a quiet 1-1/2 HP, 1-speed whirlpool pump; a 1HP, variable speed air blower with integral air heater; automatic purge cycle; an electronic control that operates the pump, blower and blower speed for continuous, pulse or wave massage modes; and a 20-minute timer. The keypad also operated the optional Jetted Neck Pillow.
Premier		A 120V system that includes a quiet 1-1/2 HP, 1-speed combination whirlpool pump/heater; a 1HP, variable speed air blower with integral air heater; (2) Chromatherapy Mood Lights; Automatic Ozone System; automatic purge cycle; an electronic control; and a 20-minute timer. Control keypad operates the pump, blower and blower speed for continuous, pulse or wave massage modes. The keypad also operates the LED Chromatherapy mood lights.
Signature		A 120V system that includes a quiet 1-1/2 HP, 1-speed combination whirlpool pump/heater; a 1HP, variable speed air blower with integral air heater; (2) Chromatherapy mood lights; Automatic Ozone System; automatic purge cycle; a digital control with LCD display window; low water level and water temperature sensors to ensure proper operation; and a 20-minute timer. Control keypad operates the pump, blower and blower speed for continuous, pulse or wave massage modes, LED Chromatherapy mood lights, optional jetted neck pillow and shows pump status, blower speed, water temperature and time remaining. Includes Bluetooth Sound Immersion.