

ThermoSetter™

Recirculation thermal balancing valve



01325/21 NA
Replaces 01325/20 NA

116 series



Function

The ThermoSetter™ adjustable thermal balancing valve is used for automatic balancing of recirculation loops in domestic hot water systems, to speed hot water delivery, reduce water waste and save energy. The internal thermostatic balancing cartridge automatically modulates flow to ensure a constant temperature in the recirculation piping system. The 116 Series has an adjustment knob with 95°F to 140°F (35°C to 60°C), sizes ½", ¾"; 95°F to 150°F (35°C to 65°C), sizes 1", 1¼" temperature scale indication. An integral dry-well holds a slide-in temperature gauge for local indication, or a sensor for remote temperature sensing. The optional check valve protects against circuit thermo-syphoning.

The 1162xx and 1166xx Series is available with a "disinfection" by-pass cartridge, for use in systems which are designed to perform thermal disinfection for prevention of Legionella. When the disinfection cartridge senses 160°F (70°C) -1162xx, or 140°F (60°C)-1166xx, water (2 available temperature options), indicating disinfection control mode, it automatically opens a by-pass flow path to allow sufficient flow for disinfection to occur. When the temperature drops back to normal range, the disinfection by-pass cartridge closes to return flow control to the balancing cartridge.

The 1163xx Series is also available with a "disinfection" valve that is controlled by a 24V spring return thermo-electric actuator, rather than thermostatically, thus allowing thermal disinfection mode to be controlled remotely by an automation system.

The valve complies with NSF/ANSI/CAN 61 (180°F/82°C Commercial Hot) as certified by ICC-ES, and complies with NSF/ANSI 372, low lead, and codes IPC and UPC or use in accordance with the US and Canadian plumbing codes, as certified by ICC-ES.

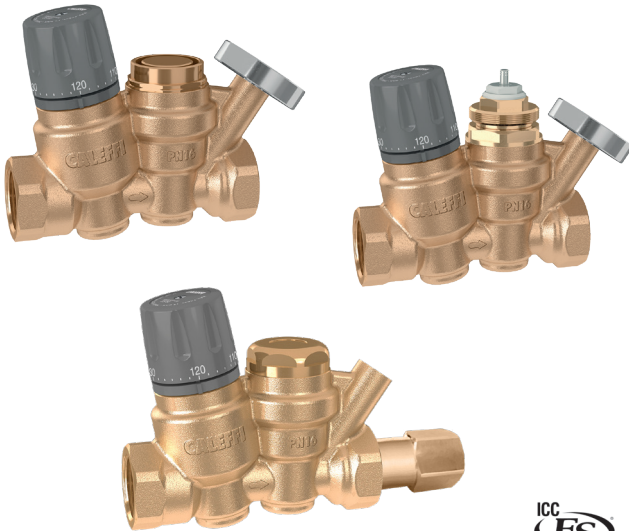

NSF/ANSI/CAN 61



Product range

- 1161 series ThermoSetter without disinfection function, models with and without temperature gauge, with and without check valve..... connections ½", ¾", 1" & 1¼" NPT female
- 1162 series ThermoSetter with disinfection function bypass cartridge (160°F (70°C)), complete with temperature gauge, w/ and w/o check valve..... connections ½", ¾", 1" & 1¼" NPT female
- 1163 series ThermoSetter with actuator disinfection function, complete with temperature gauge, with and without check valve..... connections ½", ¾", 1" & 1¼" NPT female
- 1166 series ThermoSetter with disinfection function bypass cartridge (140°F (60°C)), complete with temperature gauge, w/ and w/o check valve..... connections ½", ¾", 1" & 1¼" NPT female

Technical specifications

Materials:

Body: DZR low-lead brass
Adjustable cartridge: stainless steel & copper
Springs: stainless steel AISI 302 (EN 10270-3)
Hydraulic seals: peroxide-cured EPDM
Adjustment knob: ABS

Performance:

Suitable fluid: water
Max. working pressure: 230 psi (16 bar)
Max. differential pressure: 15 psi (1 bar)
Max. inlet temperature: 195°F (90°C)
Adjustment temperature range: sizes ½" & ¾" : 95–140°F (35 – 60°C)
sizes 1" & 1¼": 95 - 150°F (35 – 65°C)
Factory setting: 130°F (55°C)

	½" & ¾"	1" & 1¼"
Cv (Kv) max:	2.1 (1.8)	4.4 (3.8)
Cv (Kv) dis:	1.2 (1.0)	2.3 (2.0)
Cv (Kv) min:	0.23 (0.2)	1.0 (0.9)
Cv (Kv) design:	0.52 (0.45)	1.9 (1.6)

Disinfection performance:

Disinfection temperature: 1162xx series-160°F (70°C)
1166xx series-140°F (60°C)
Closing temperature: 1162xx series-170°F (75°C)
1166xx series-150°F (65°C)

Connections:

Main connections: ½", ¾", 1" & 1¼" NPT female
Temperature gauge/sensor dry-well: Ø 10 mm metric

Temperature gauge code 116010

Scale: 30 - 180°F (0–80°C)
Diameter: 1½" (40 mm)
Stem diameter: 0.35" (9 mm)

Technical specifications of insulation

Materials: closed cell expanded PE-X
Thickness: ½ inch (13 mm)
Density: -internal part: 1.9 lb/ft³ (30 kg/m³)
-external part: 5.0 lb/ ft³ (80 kg/m³)
Thermal conductivity (DIN52612):
- at 32°F (0°C): 0.82 BTU · in/hr · ft² · °F (0.0345 W/(m · K))
- at 105°F (40°C): 0.94 BTU · in/hr · ft² · °F (0.0398 W/(m · K))
Coefficient of resistance to the diffusion of vapor: > 1,300
Working temperature range: 32–212°F (0–100°C)
Flammability (ASTM D 635): Class V0

Certifications:

- 1.Complies with codes IPC and UPC and standard NSF/ANSI/CAN 61 (180°F/82°C Commercial Hot), as certified by ICC-ES, file PMG-1512.
- 2.Complies with NSF/ANSI 372, low lead, as certified by ICC-ES, file PMG-1360.

Dimensions

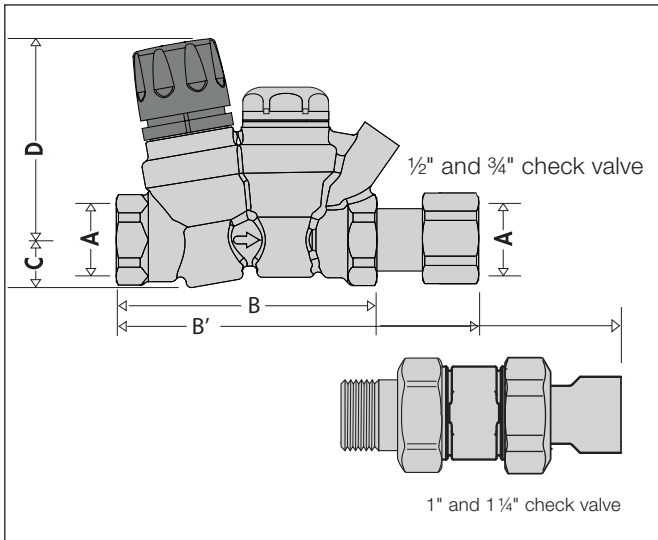

Code	A	B	B*	C	D	Wt (lb/kg)*
116140A(C)	1/2" NPT F	4"	5 7/16"	3/4"	3"	1.6 / 0.72
116141A(C)**	1/2" NPT F	4"	5 7/16"	3/4"	3"	1.7 / 0.75
116150A(C)	3/4" NPT F	4"	5 5/8"	3/4"	3"	1.5 / 0.70
116151A(C)**	3/4" NPT F	4"	5 5/8"	3/4"	3"	1.6 / 0.72
116160A(C)	1" NPT F	4 1/2"	9 1/2"	1"	4 3/8"	2.1 / 0.95
116161A(C)**	1" NPT F	4 1/2"	9 1/2"	1"	4 3/8"	2.2 / 1.00
116170A(C)	1 1/4" NPT F	4 1/2"	9 3/4"	1"	4 3/8"	2.0 / 0.90
116171A(C)**	1 1/4" NPT F	4 1/2"	9 3/4"	1"	4 3/8"	2.1 / 0.95

*Models with check valve (C) end-to-end dimension is B'.
Add 0.2 lb for models with check valve.

**with integral outlet temperature gauge.

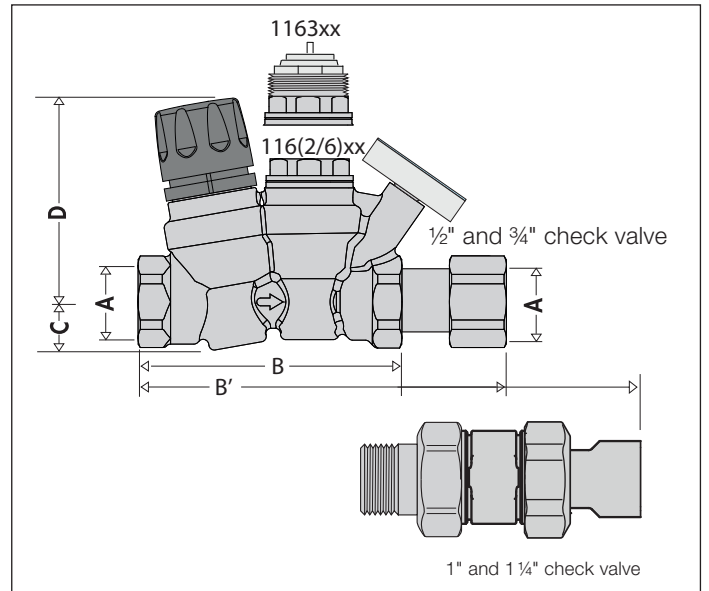

Code	A	B	B*	C	D	Wt (lb/kg)
116D40A(C)**	1/2" NPT F	4"	5 7/16"	3/4"	3"	1.7 / 0.75
116D50A(C)**	3/4" NPT F	4"	5 5/8"	3/4"	3"	1.5 / 0.70
116D60A(C)**	1" NPT F	4 1/2"	9 1/2"	1"	4 3/8"	1.8 / 0.80
116D70A(C)**	1 1/4" NPT F	4 1/2"	9 3/4"	1"	4 3/8"	1.7 / 0.75
116340A(C)	1/2" NPT F	4"	5 7/16"	3/4"	3"	1.7 / 0.75
116350A(C)	3/4" NPT F	4"	5 5/8"	3/4"	3"	1.5 / 0.70
116360A(C)	1" NPT F	4 1/2"	9 1/2"	1"	4 3/8"	2.3 / 1.04
116370A(C)	1 1/4" NPT F	4 1/2"	9 3/4"	1"	4 3/8"	2.2 / 1.00

*Models with check valve (C) end-to-end dimension is B'.
Add 0.2 lb for models with check valve.

**D=2 for models with 160°F (70°C) disinfection temperature;
D=6 for models with 140°F (60°C) disinfection temperature.

NOTE: All models in this table come complete with integral outlet temperature gauge.

Operating principle

The ThermoSetter adjustable thermal balancing valve, 116 series models, installed at the end of each branch of the domestic hot water recirculation system, automatically maintains the set temperature. It controls the water flow rate according to the inlet temperature with the internal adjustable thermostatic cartridge. The thermostatic cartridge modulates the valve opening in response to changing water temperature, and when reaching the temperature setting, closes the valve to minimum flow position. A recirculation pump distributes flow to all the branches resulting in effective automatic thermal balancing. The automatic response allows each hot water branch to deliver hot water to each fixture. The ThermoSetter works perfectly with variable speed recirculation pumps for optimal energy usage.

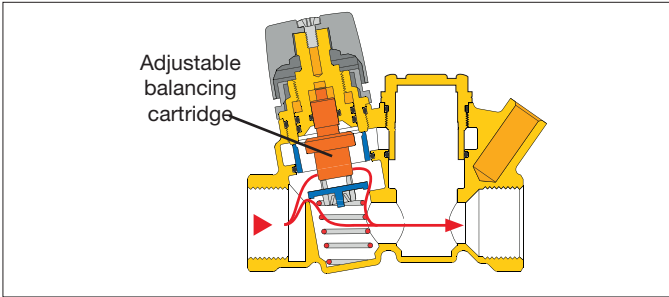

Optional check valve are available for all models, which protect against circuit thermo-syphoning.

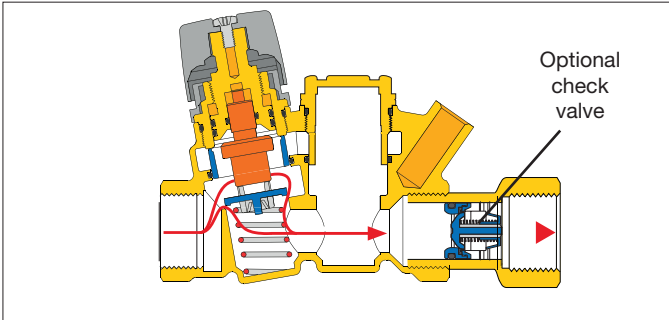

For systems using thermal disinfection for Legionella growth protection, the 1162xx series models incorporate a second thermostatic by-pass cartridge that activates at 160°F. The 1166xx series models activate at 140°F. A second flow path opens providing flow for the disinfection process which is independent of the primary balancing cartridge.

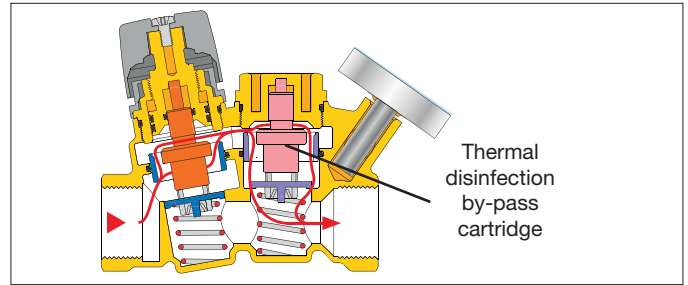

Alternately, the 1163xx series models incorporate a by-pass valve for thermal disinfection which is activated by an optional field mounted thermo-electric actuator, code 656 series, controlled by an automation system.

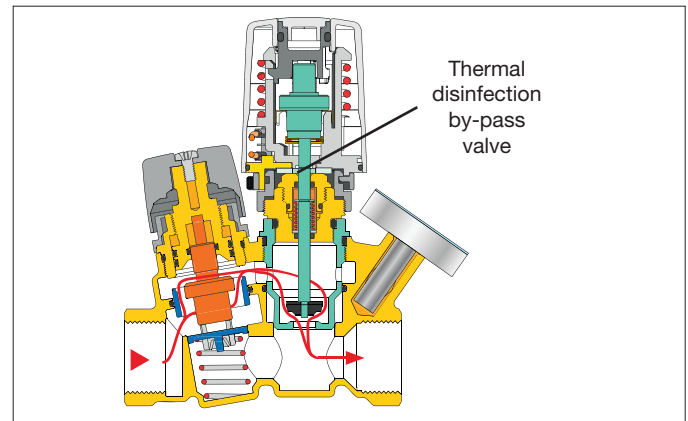

Operating mode

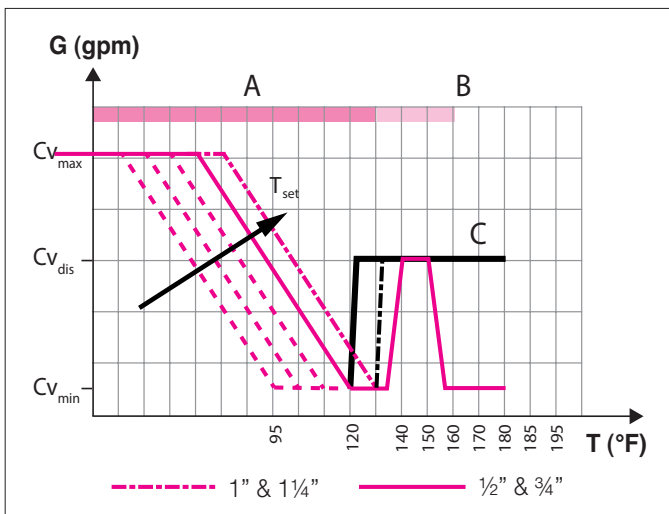

For 1166xx series with 140°F bypass temperature and 150°F closing temperature.

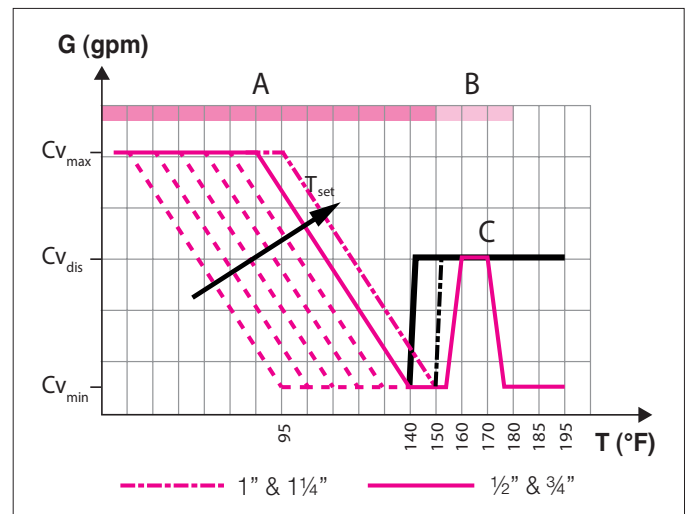

For 1162xx series with 160°F bypass temperature and 170°F closing temperature.

	½" & ¾"	1" & 1¼"
	Cv (Kv)	Cv (Kv)
Cv (Kv) max:	2.1 (1.8)	4.4 (3.8)
Cv (Kv) dis:	1.2 (1.0)	2.3 (2.0)
Cv (Kv) min:	0.23 (0.2)	1.0 (0.9)

The graph shows the variation of the Cv value depending on the valve operating mode (A, B, C) and on the inlet temperature of the domestic hot water.

Operating mode A - Temperature control

Cv max: = 2.1 maximum flow state when operating in temperature control mode (cartridge fully open).

Cv min: = 0.23 minimum flow state when operating at set point in temperature control mode (cartridge nearly closed).

Operating mode B - Automatic thermostatic disinfection

Cv dis: = 1.2 maximum flow state when operating in thermostatic controlled thermal disinfection mode with a temperature of 160°F (70°C).

Operating mode C - Actuator-controlled disinfection

Cv dis: = 1.2 maximum flow state when operating in actuator-controlled thermal disinfection mode using a thermo-electric actuator, code 656 series.

Operating mode A - Temperature control

At the set temperature, the valve plug, controlled by the thermostatic balancing cartridge, gradually closes the outlet to the minimum. The outlet never fully closes to always allow a minimum flow for temperature sensing and to prevent recirculation pump dead-heading. If the temperature decreases, the outlet increases, causing flow and thus temperature to increase back to the set temperature as shown in curve 1. If temperature exceeds the set-point, the plug stays in the minimum closed position as shown in curve 2. The balancing cartridge has a throttling range of 60°F, from full open to minimum position.

① Thermostatic balancing control

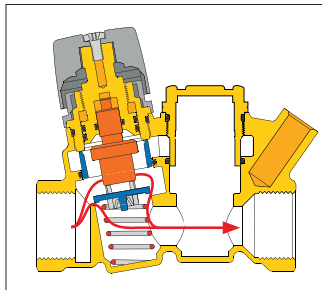

② Minimum flow rate

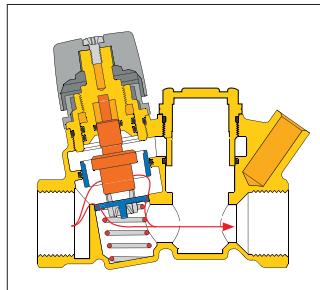

Operating mode B - Automatic thermostatic disinfection

The 1162xx and 1166xx series operating characteristic curves for operating mode B are curves 1, 2, 3 and 4. When a temperature higher than about 155°F (68°C) is reached, a by-pass passage begins to open to activate the second thermostatic cartridge which controls the thermal disinfection process, allowing flow independent of the operation of the thermostatic balancing cartridge. This allows water flow through a special by-pass port, opening the flow path up until the by-pass temperature is attained shown in curve 3. If the temperature continues rising beyond this point, the flow is reduced through the by-pass port to allow thermal balancing even during the disinfection process. When temperature reaches closing temperature, the disinfection by-pass port closes to protect the system fixtures from the effects of excessive temperatures, as shown in curve 4.

③ Thermostatic disinfection by-pass

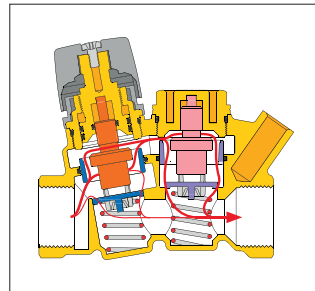

④ Thermal shut-off

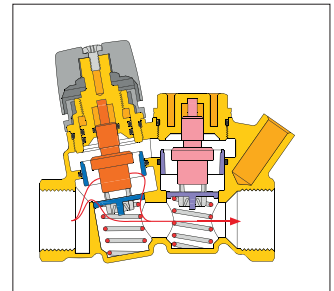

Operating mode C - Actuator-controlled disinfection

The 1163xx series operating characteristic curves for operating mode C are curves 1, 2 and 5. When the disinfection operating temperature setting of the electronic disinfection system is reached, the thermo-electric actuator 656 series (which is controlled by a dedicated electronic control system), is energized to operate the by-pass valve to control the disinfection process, allowing flow independent of the operation of the thermostatic balancing cartridge shown in curve 5. In this case, the minimum head loss is produced during this thermal disinfection process.

⑤ Electric controlled disinfection by-pass

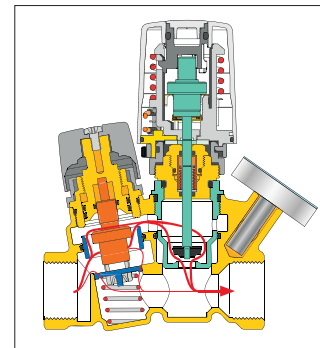

Flow characteristics

The ThermoSetter thermostatic balancing valve is designed to balance individual branches of domestic hot water recirculation systems, based on the temperature at the valve. It automatically modulates flow to maintain hot water availability to all fixtures in the branch circuit. The valve is at minimum flow ($Cv = .23$) when the incoming water temperature is equal to the set-point position of the adjustment dial. The valve opens as incoming water temperature drops.

For pressure loss calculations in the recirculation system, follow traditional pipe sizing and head loss practices. For pressure loss calculations across the ThermoSetter valve, use the design curve shown in the graph below. This line represents a typical valve position under normal working conditions ($\Delta T = 10^\circ F$). Determine the pressure drop across the valve by selecting the branch design GPM on the graph X-axis, draw a vertical line up to the "design" curve, then go across to the Y-axis to find the design pressure drop. Include that pressure drop in your head loss calculations for the circuit.

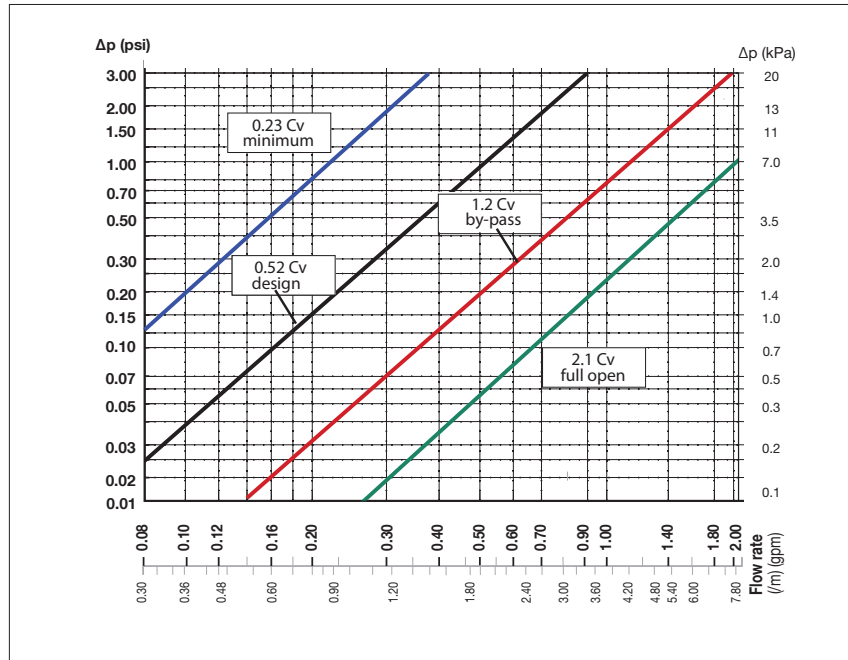

Sizes 1/2" and 3/4"

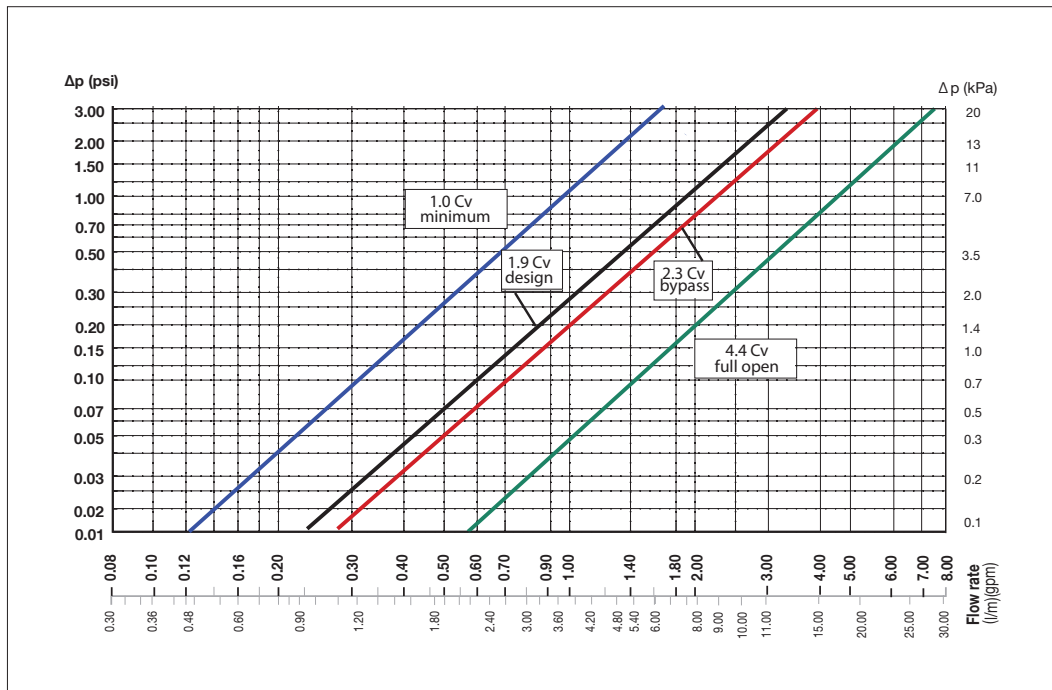

Sizes 1" and 1 1/4"

The "by-pass mode" curve in the charts above shows the head loss of the valve when it is in by-pass thermal disinfection mode for Legionella control.

System sizing

For flow rate calculations in the recirculation system, the pump is sized to provide sufficient flow to compensate for the total heat loss in all the supply branches to the furthest fixture in each circuit. Heat loss in return lines, downstream of the balancing valves, is irrelevant and not included in the flow rate calculations.

The flow rate calculation formula to use is: $GPM = BTU/h / \Delta T \times 500$.

Common design practice for recirculation lines is to use a ΔT of 10°F. This is the temperature difference of the recirculating water between the heat source and to the furthest fixture in each circuit. Assuming the common value of a $\Delta T = 10^\circ F$, the equation simplifies to:

$GPM = BTU/h / 5000$.

BTU/h heat loss, will vary based on pipe type and insulation. Heat loss tables and charts are available from a variety of sources.

Example:

Calculate the recirculation circuit flow rate for 100 feet of 3/4" non-insulated copper pipe. Assume an average heat loss of 30 BTU/h per foot.

30 BTU/h per foot x 100 feet = 3000 BTU/h heat loss in the supply piping.

Flow rate = 3000 / 5000 = 0.6 GPM flow required in that circuit.

Temperature adjustment and locking

Set the desired recirculation system temperature by turning the adjustment knob. The graduated scale shows the temperatures at which the adjustment knob can be set.

After adjusting the temperature, the setting can be locked at the desired value using the adjustment knob. Unscrew the locking screw at the top of the adjustment knob, remove the knob and then put it back on so that the internal groove couples with the protrusion on the knob holder nut. When this lock is used, the reference of the indication of the temperature values on the knob is lost. To restore it, completely unscrew the locking screw. Reposition the knob on MAX value. Insert and tighten the locking screw.

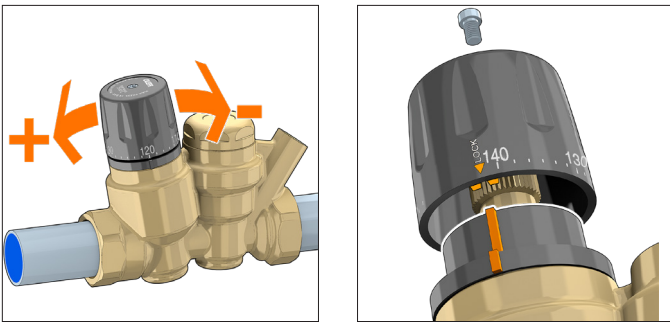

Maintenance

Both the adjustable balancing cartridge and the disinfection control cartridge can be removed from the valve body for periodic inspection, cleaning or replacement.

Replacement disinfection by-pass cartridges:

160°F (70°C) for 1162 series...F0000580

140°F (60°C) for 1166 series...F0001286

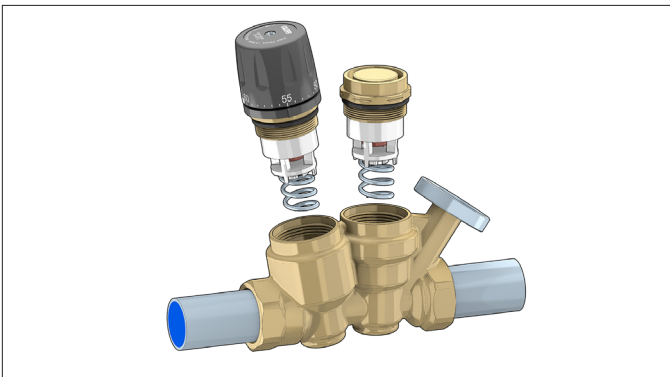

Installation

Before installing the ThermoSetter, flush the pipes to make sure that impurities in the system will not interfere with valve performance. Strainers of sufficient capacity at the inlet from the water main are highly recommended. The ThermoSetter can be installed in any position, vertical or horizontal, following the flow direction indicated by the arrow on the valve body. The ThermoSetter must be installed according to the diagrams given here. It must be installed to allow free access for checking on operation and maintenance procedures.

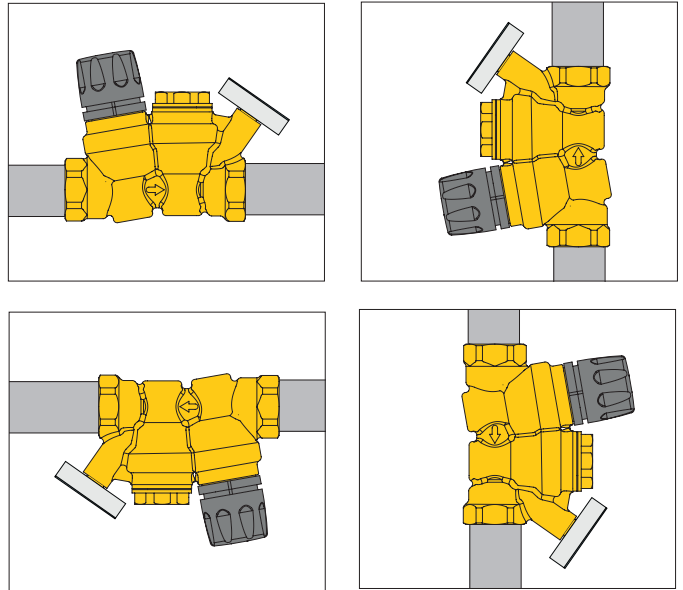

Insulation shell

The ThermoSetter thermal balancing valve can be supplied with an optional insulation shell, purchased separately, to minimize heat loss.

Code	Description
CBN116140	Insulation shell for 1161, 1162, 1163 for 1/2" and 3/4" sizes
CBN116160	Insulation shell for 1161, 1162, 1163 for 1" and 1 1/4" sizes



Typical application diagram

Hot water recirculation with thermal balancing valves

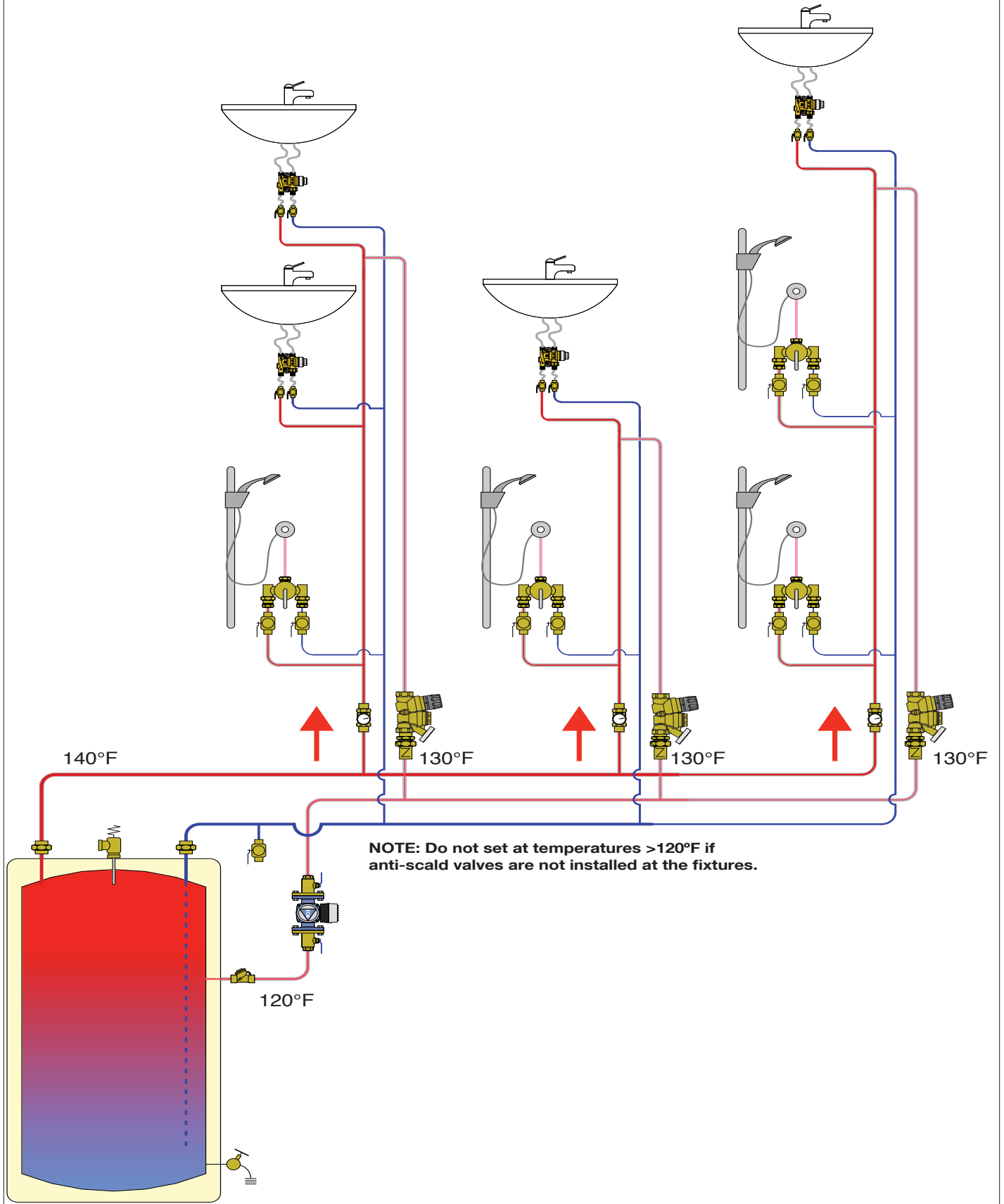

Accessories

ThermoSetter codes 116140A and 116150A come standard without temperature gauge, but temperature gauge, code 116010 can be field-installed later for confirming the temperature of the hot water in the circuit.



The temperature gauge dry-well can also be used for inserting a special immersion probe (with $\varnothing < 10$ mm) for remote control of the disinfection temperature by a dedicated electronic control unit.

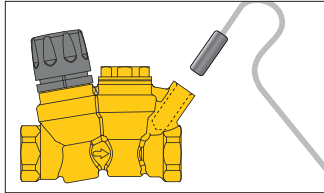

Replacement cartridges

Code	Description
11600	Actuator disinfection cartridge for use with 656 actuator
F0001516	Main balancing cartridge for 1/2" and 3/4" sizes

(Contact Caleffi for main balancing cartridge for 1" and 1 1/4" sizes)

Inline check valves

DZR low-lead brass.

Max working pressure: 150 psi

Max. working temperature: 250°F (120°C)

Code	Description
NA10469	1/2" FNPT x MNPT inline check valve
NA10467	3/4" FNPT x MNPT inline check valve
NA10361	1" MNPT in x 1" FNPT out
NA10371	1 1/4" MNPT in x 1 1/4" FNPT out

SPECIFICATION SUMMARY

Series 1161

Thermal balancing valve for domestic hot water recirculation circuits. Dezincification resistant low-lead brass body (<0.25% Lead content) certified to NSF/ANSI 372 by ICC-ES, file PMG-1360. Certified to NSF/ANSI 61 (180°F/82°C Commercial Hot), by ICC-ES, file PMG-1512. Sizes 1/2", 3/4", 1" and 1 1/4" with NPT female connections. Adjustable thermostatic cartridge. Peroxide-cured EPDM hydraulic seals. Temperature gauge/probe dry-well \varnothing 10 mm. Maximum working pressure 230 psi (16 bar). Maximum differential pressure 15 psi (1 bar). Adjustment temperature range 95°F to 140°F (35°C-60°C), sizes 1/2", 3/4"; 95°F to 150°F (35°C to 65°C), sizes 1", 1 1/4". Flow rating: 2.1 Cv (1.8 Kv) maximum, 0.23 Cv (0.2 Kv) minimum, 0.52 Cv (0.45 Kv) design. Equipped with: ABS adjustment knob with temperature adjustment scale for manual setting and tamper-proof adjustment locking screw. Provide with optional outlet temperature gauge with 30°F to 180°F (0°C-80°C) temperature scale. Provide with optional check valve. Pre-formed insulation shell is available for field installation.

Series 1162 & 1166

Thermal balancing valve for domestic hot water recirculation circuits with thermostatic by-pass valve for thermal disinfection function. Dezincification resistant low-lead brass body (<0.25% Lead content) certified to NSF/ANSI 372 by ICC-ES, file PMG-1360. Certified to NSF/ANSI 61 (180°F/82°C Commercial Hot), by ICC-ES, file PMG-1512. Sizes 1/2", 3/4", 1" and 1 1/4" with NPT female connections. Adjustable thermostatic cartridge. Peroxide-cured EPDM hydraulic seals. Temperature gauge/probe dry-well \varnothing 10 mm. Maximum working pressure 230 psi (16 bar). Maximum differential pressure 15 psi (1 bar). Adjustment temperature range 95°F to 140°F (35°C-60°C), sizes 1/2", 3/4"; 95°F to 150°F (35°C to 65°C), sizes 1", 1 1/4". Disinfection temperature 160°F (70°C) for 1162 series, 140°F (60°C) for 1166 series. Closing temperature 170°F (75°C) for 1162 series, 150°F (65°C) for 1166 series. Flow rating: 2.1 Cv (1.8 Kv) maximum, 1.2 Cv (1.0 Kv) disinfection, 0.23 Cv (0.2 Kv) minimum, 0.52 Cv (0.45 Kv) design. Equipped with: ABS adjustment knob with temperature adjustment scale for manual setting and tamper-proof adjustment locking screw, outlet temperature gauge with 30°F to 180°F (0°C-80°C) temperature scale. Provide with optional check valve. Pre-formed insulation shell is available for field installation.

Series 1163

Thermal balancing valve for domestic hot water recirculation circuits with by-pass valve for thermal disinfection function with optional code 656 series thermo-electric actuator. Dezincification resistant low-lead brass body (<0.25% Lead content) certified to NSF/ANSI 372 by ICC-ES, file PMG-1360. Certified to NSF/ANSI 61 (180°F/82°C Commercial Hot), by ICC-ES, file PMG-1512. Sizes 1/2", 3/4", 1" and 1 1/4" with NPT female connections. Adjustable thermostatic cartridge. Peroxide-cured EPDM hydraulic seals. Temperature gauge/probe dry-well \varnothing 10 mm. Maximum working pressure 230 psi (16 bar). Maximum differential pressure 15 psi (1 bar). Adjustment temperature range 95°F to 140°F (35°C-60°C), sizes 1/2", 3/4"; 95°F to 150°F (35°C to 65°C), sizes 1", 1 1/4". Disinfection temperature 160°F (70°C). Closing temperature 170°F (75°C). Flow rating: 2.1 Cv (1.8 Kv) maximum, 1.2 Cv (1.0 Kv) disinfection, 0.23 Cv (0.2 Kv) minimum, 0.52 Cv (0.45 Kv) design. Equipped with: ABS adjustment knob with temperature adjustment scale for manual setting and tamper-proof adjustment locking screw, outlet temperature gauge with 30°F to 180°F (0°C-80°C) temperature scale. Provide with optional check valve. Pre-formed insulation shell is available for field installation.

We reserve the right to make changes and improvements to the products and related data in this publication, at any time and without prior notice.



Caleffi North America, Inc.
3883 W. Milwaukee Road
Milwaukee, WI 53208
Tel: 414-238-2360 · Fax: 414-238-2366
sales@caleffi.com · www.caleffi.com
© Copyright 2021 Caleffi North America, Inc.