

## LEGIOMIX<sup>®</sup> electronic mixing valve

© Copyright 2021 Caleffi

**6000 series**

### INSTALLATION AND COMMISSIONING MANUAL

#### Function

The electronic mixing valve is used in centralized systems that produce and distribute domestic hot water. It maintains the temperature of the domestic hot water delivered to the user when there are variations in the temperature and pressure of the hot and cold water at the inlet or in the draw-off flow rate. The LEGIOMIX<sup>®</sup> electronic mixing valve provides precise temperature control over very low and very high flow rate demand, minimal pressure drop with a ball valve control element, automatic self-cleaning to prevent scale formation and easy-to-use digital interface with data logging, alarming and status indication. The LEGIOMIX electronic mixing valve is furnished with a controller with LCD user interface that provides a set of programs for circuit thermal disinfection to kill Legionella. The controller is configurable via keypad, or local or remote computer. Depending on the type of system and habits of the user, temperature levels and operation times can be programmed as desired. In addition, it comes standard with monitoring and remote control connections.

The LEGIOMIX 6000 series electronic mixing valve is powered by **24 VAC**. (Caleffi provides a 115 / 24 VAC transformer in the package.) It is ICC-ES certified to ASSE 1017 and CSA B125.3. It complies with codes IPC, IRC, NPC and UPC for use in accordance with the US and Canadian plumbing codes, and standard NSF/ANSI 372, low lead. Also, it meets the requirement of CSA Z317.1 Special Requirement for Plumbing Installations in Health Care Facilities, certified by ICC-ES.



**Connect to 24 VAC  
power source**



ASSE 1017

Scan to view

6000 LEGIOMIX<sup>®</sup>**Installation Tip**



## SAFETY INSTRUCTION

This safety alert symbol will be used in this manual to draw attention to safety related instructions. When used, the safety symbol means **ATTENTION! BECOME ALERT! YOUR SAFETY IS INVOLVED! FAILURE TO FOLLOW THESE INSTRUCTIONS MAY RESULT IN A SAFETY HAZARD.**



**CAUTION:** All work must be performed by qualified personnel trained in the proper application, installation, and maintenance of systems in accordance with all applicable codes and ordinances.



**CAUTION:** If the electronic mixing valve is not installed, commissioned and maintained properly, according to the instructions contained in this manual, it may not operate correctly and may endanger the user.



**CAUTION:** Make sure that all the connecting pipework is water tight.



**CAUTION:** When making the water connections, make sure that the pipework connecting the LEGIOMIX electronic mixing valve is not mechanically overstressed. Over time this could cause breakages, with consequent water losses which, in turn, could cause harm to property and/or people.



**CAUTION:** Water temperatures higher than 100°F (38°C) can be dangerous. During the installation, commissioning and maintenance of the LEGIOMIX electronic mixing valve, take the necessary precautions to ensure that such temperatures do not endanger people.



**CAUTION:** Safety measures must be in place before engaging disinfection mode. Anti-scald protection devices, certified to ASSE 1016 or ASSE 1070, at all downstream fixtures, must be installed.



**CAUTION:** To prevent any damage which will cause the electronic mixing valve to not operate correctly, treat highly aggressive water before entering the electronic mixing valve. Be sure water hardness is less than 10 grains.



**CAUTION: IMPORTANT:** Risk of electric shock. The back panel and mixing valve contain live circuits. Cut off the electric supply before performing work. Failure to follow these instructions may result in injury of persons or damage to property.



**CAUTION:** When turning on confirm the desired language. English is the default language. But, if not selected after 1 minute, the menu will go directly to the date and time choice. Language can then be selected always in “settings”.

**Leave this manual for the user.**



## CONSIGNE DE SÉCURITÉ

Ce symbole d'avertissement servira dans ce manuel à attirer l'attention sur la sécurité concernant instructions. Lorsqu'il est utilisé, ce symbole signifie.

**ATTENTION! DEVEZ-VOUS ÊTRE ALERTES ! VOTRE SÉCURITÉ EST EN JEU ! NE PAS SUIVRE CES INSTRUCTIONS PEUT PROVOQUER UN RISQUE DE SÉCURITÉ.**



**ATTENTION:** Tous les travaux doivent être effectués par du personnel qualifié formé à la bonne application, installation et maintenance des systèmes conformément aux codes et règlements locaux.



**ATTENTION:** Si le réducteur de pression, mitigeur électronique, n'est pas installé, mis en service et entretenu correctement, selon les instructions contenues dans ce manuel, il peut ne pas fonctionner correctement et peut mettre en danger l'utilisateur.



**ATTENTION:** S'assurer que tous les raccordements sont étanches.



**ATTENTION:** Lorsque vous effectuez les raccordements d'eau, assurez-vous que la tuyauterie reliant le LEGIOMIX mitigeur électronique n'est pas mécaniquement overstressed. Au fil du temps, ceci pourrait causer des ruptures, avec pour conséquence des pertes en eau qui, à leur tour, peuvent causer des dommages à la propriété et/ou les gens.



**ATTENTION:** Les températures de l'eau supérieure à 100°F (38°C) peut être dangereux. Au cours de l'installation, mise en service et l'entretien de le réducteur de pression, le LEGIOMIX mitigeur électronique, prendre les précautions nécessaires afin de s'assurer que de tels températures ne compromettent pas les gens.



**ATTENTION:** Des mesures de sécurité doivent être en place avant d'engager le mode de désinfection. Les dispositifs de protection anti-brûlure, certifié à ASSE 1016 ou 1070 l'ASSE, à tous les appareils en aval, doit être installé.



**ATTENTION:** Pour prévenir tout dommage qui provoque le mitigeur électronique à ne pas fonctionner correctement, le traitement de l'eau très agressive avant d'entrer dans la vanne de mélange électronique. Assurez-vous que la dureté de l'eau est inférieure à 10 grains.



**ATTENTION:** Risque de choc électrique. Le fond d'armoire et la vanne mélangeuse sont sous tension. Couper l'alimentation électrique avant toute intervention. Le non respect de ces règles de sécurité peut entraîner des dégâts matériels et/ou des blessures aux personnes.



**ATTENTION:** Lors du passage de confirmer la langue désirée. L'anglais est la langue par défaut. Si la langue n'est pas sélectionnée après 1 minute, le menu Aller directement à la date et l'heure de choix. La langue peut alors être sélectionné toujours dans "Paramètres".

**LAISSEZ CE MANUEL AVEC L'UTILISATEUR**



**WARNING:** This product can expose you to chemicals including lead, which is known to the State of California to cause cancer and birth defects or other reproductive harm. For more information go to [www.P65Warnings.ca.gov](http://www.P65Warnings.ca.gov).

**AVERTISSEMENT:** Ce produit peut vous exposer à des produits chimiques comme le plomb, qui est connu dans l'État de Californie pour causer le cancer, dommages à la naissance ou autre. Pour plus d'informations rendez-vous [www.P65Warnings.ca.gov](http://www.P65Warnings.ca.gov).

**Product range**

6000 series Electronic mixing valve with programmable thermal disinfection, 24 VAC with union connections, NPT male, sweat and press.....sizes ¾", 1", 1¼", 1½" & 2"

6000 series Electronic mixing valve with programmable thermal disinfection, 24 VAC with ANSI 150 RF flanged connections.....sizes 2½" & 3"

Code 755052 Modbus-to-BACnet gateway

**Technical specifications**

**Valve body**

- Materials:
  - Body: DZR low-lead brass
  - Ball: sizes ¾" - 2": low-lead brass, chrome-plated  
 sizes 2½" & 3": AISI 316 stainless steel
  - Slip-on flanges for sizes 2½" & 3": galvanized carbon steel
  - O-ring seals: peroxide-cured EPDM
  - Ball seats: PTFE

- Max. body pressure rating: 230 psi (16 bar)
- Max working pressure: 150 psi (10 bar)
- Max. inlet temperature: 212°F (100°C)
- Temperature gauge scale: 32 - 176°F (0 - 80°C)
- Suitable fluids: water
- Max. water hardness: 10 grains

- Main connections: -NPT male, sweat and press union ¾", 1", 1¼", 1½" and 2"
- ANSI B16.5 150 CLASS RF 2½" & 3"

**Actuator, 3-wire floating fail-in-place**

- Electric supply: 24 VAC - 50/60 Hz
- Power consumption: 6 VA
- Protection cover: self-extinguishing VO
- Protection class: IP 65 (NEMA 4/4X)
- Ambient temperature range: 14 - 130°F (-10 - 55°C)
- Electric supply cable length: 31½" (0.8 m)

- Max. distance for control signal wire:
  - 500 ft (150 m) cable 2 conductor x AWG 18
  - 800 ft (250 m) cable 2 conductor x AWG 16

**Controller, LCD user interface/display**

Materials: - Housing: self-extinguishing ABS, color white RAL 1467  
 - Cover: self-extinguishing SAN, smoked transparent  
 Electric supply: 24 VAC (min 21.6, max 26.0 VAC)- 50/60 Hz  
 (115/24 VAC transformer included in package)  
 Power consumption: 6.0 VA  
 Adjustment temperature range: 70 - 185°F (20 - 85°C)  
 Disinfection temperature range: 100 - 185°F (40 - 85°C)  
 Ambient temperature range: 32 - 120°F (0 - 50°C)  
 Protection class: IP 54 (wall mounting)  
 (Class II appliance)  
 Mounting bracket: DIN rail

Mixing valve actuator current draw: 1 A max / 24 V  
 Alarm relay rating (R2): 5 A resistance (2 A inductance) / 24 V  
 Contact rating (R1, R3, R4): 10 A resistance (2 A inductance) / 24 V  
 (A 50 VA Class 2 120/24 VAC transformer is included)

Fuses: 1 (main): 400 mA  
 Fuses: 2 (mixing valve): 1 A  
 Charge reserve: 15 days in the event of electric supply failure,  
 with a 3 cell rechargeable 3.6 V 140 mAh buffer battery  
 Battery recharging time: 140 hours  
 Approvals: CE, FCC part 15

**Temperature sensors**

Body material: stainless steel  
 Type of sensitive element: NTC  
 Working temperature range: 14 - 260°F (-10 - 125° C)  
 Resistance: 10,000 Ohms at 77° F (25° C)  
 Time constant: 2.5  
 Max. distance for mixed outlet or return (recirculation) sensor:

500 ft (150 m) cable 2 conductor x AWG 18  
 800 ft (250 m) cable 2 conductor x AWG 16

**Mixing valve performance**

Accuracy: ± 3° F (± 2° C)  
 Max. operating differential pressure (dynamic): 20 psid (1.4 bar)  
 Max. ratio between inlet pressures (H/C or C/H): 2.1

**Certifications**

1. ASSE 1017/CSA B125.3, certified by ICC-ES, file PMG-1357.
2. Meets the requirement of CSA Z317.1 Special Requirement for Plumbing Installations in Health Care Facilities, certified by ICC-ES, file PMG-1357.
3. Complies with NSF/ANSI 372, Drinking Water System Components Lead Content Reduction of Lead in Drinking Water Act, California Health and Safety Code 116875S.3874, Reduction of Lead in Drinking Water Act, as certified by ICC-ES, file PMG-1360.

	Recommended Flow Rates (gpm/lpm)						
Size	¾"	1"	1¼"	1½"	2"	2½"	3"
Minimum (1)	2.2 / 8.3	3.1 / 11.7	4.4 / 16.6	6.6 / 25	8.8 / 33.3	17.0 / 64	22.0 / 83.3
Design Flow (2)	27 / 102	58 / 220	66 / 250	93 / 352	131 / 495	288 / 1,090	329 / 1,245
Maximum (3)	43 / 172	94 / 356	107 / 405	152 / 575	215 / 814	470 / 1,780	537 / 2,033
Cv	9.7	21	24	34	47	105	120

**CONSULT TECHNICAL BROCHURE 1086 FOR COMPLETE GUIDANCE ON SIZING AND SELECTION.**

- (1) To ensure stable operation and a  $\pm 3^\circ\text{F}$  accurate temperature control. Minimum flow rate is 0 gpm when recirculation flow rate is greater than or equal to the valve size minimum flow rating.
- (2) Suggested maximum flow rate for optimum modulating control (at 7.5 psid pressure drop).
- (3) Maximum recommended differential pressure is 20 psid to ensure stable operation and accurate temperature control.

**Characteristic components**

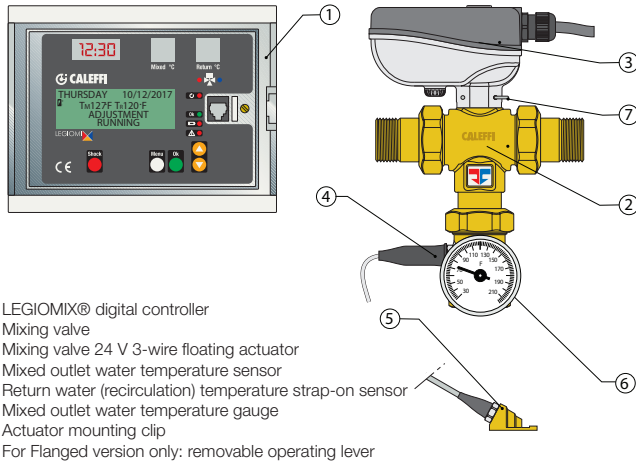

- 1) LEGIOMIX® digital controller
- 2) Mixing valve
- 3) Mixing valve 24 V 3-wire floating actuator
- 4) Mixed outlet water temperature sensor
- 5) Return water (recirculation) temperature strap-on sensor
- 6) Mixed outlet water temperature gauge
- 7) Actuator mounting clip
- 8) For Flanged version only: removable operating lever

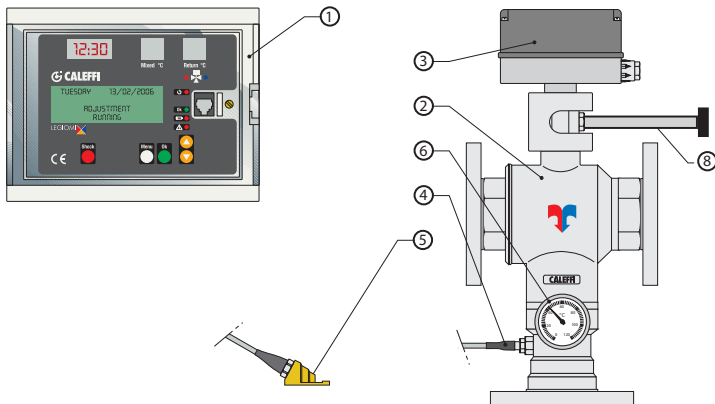

**Package contents**

- Digital controller, consisting of housing and base for electric connection
- DIN bar and mounting wall anchors
- Mixing valve
- Actuator
- Mixed outlet water temperature sensor
- Return water temperature strap-on sensor
- Spare fuses
- Installation and commissioning manual
- 115 / 24 VAC transformer

## Operating principle

The electronic mixing valve mixes hot water from storage and cold water from the main supply to maintain a constant controlled set temperature of mixed water at the outlet. The controller measures the temperature of the mixed water at the valve outlet with temperature sensor and modulates the mixing valve position to maintain the desired set temperature. Despite variations in pressure drop or hot and cold water usage or variations in inlet temperature, the LEGIOMIX automatically controls the water temperature to meet the temperature setting.

A built-in clock is used to enable optional disinfection cycle programs. The system is disinfected by raising the water temperature to a specific value for a specific time duration. Using the recirculation temperature sensor, water returning from the distribution circuits can be measured for thermal distribution control. This measured temperature is used to check and control the temperature reached over all or part of the distribution network with this sensor placed at the end of the recirculation piping circuit.

The LEGIOMIX can be used to confirm that the correct temperature and time for thermal disinfection have been reached before taking the appropriate corrective action. All the parameters are updated every day and logged, with temperatures recorded every hour. There is an RS-485 connection for remote monitoring and configuration and, with specific relays, makes alarm signals and controls available to other interconnected system devices. A Modbus-to-BACnet gateway and inlet check valves are available separately.

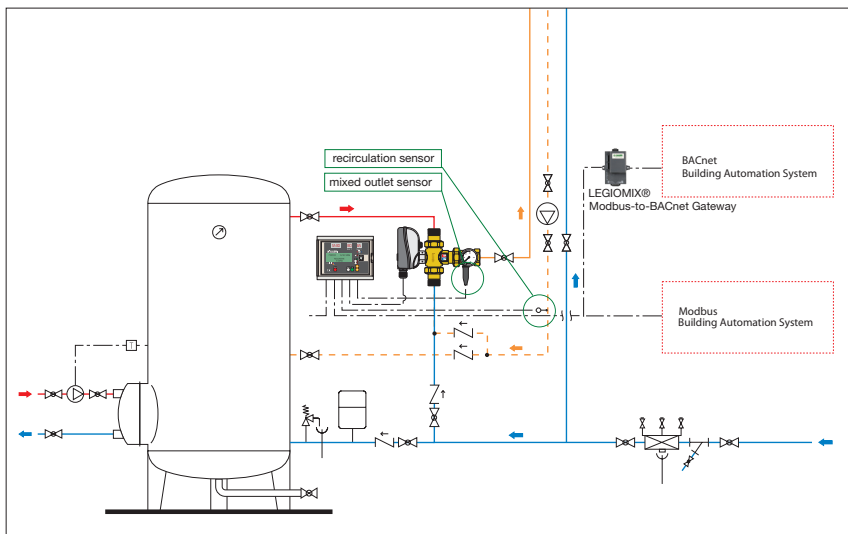

### Modbus-to-BACnet gateway for remote control

The LEGIOMIX Modbus-to-BACnet gateway, code 755052, allows the transfer of data to a Building Automation System using BACnet communication protocol.

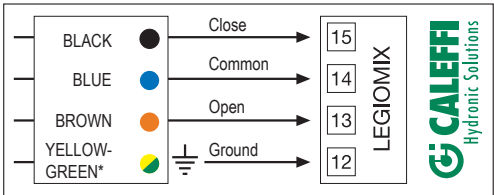
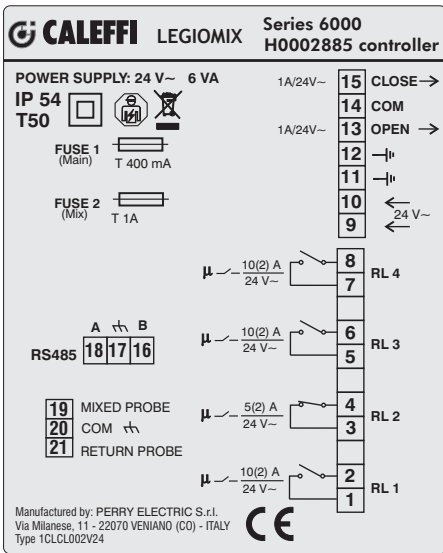
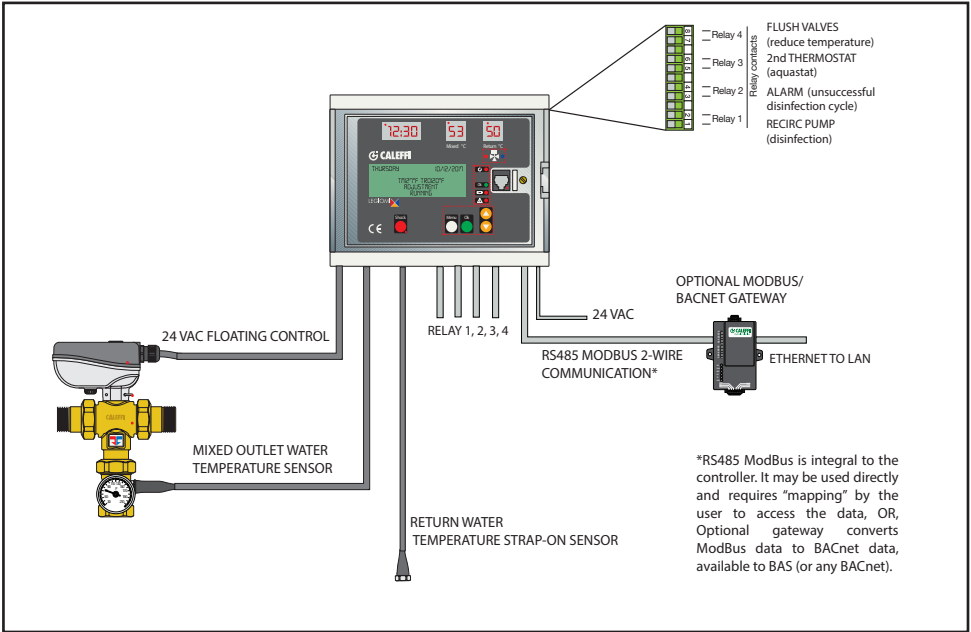

**Actuator-to-Control Wiring**

Actuator has 3 extra wires (red/white/green) for an end switch and are not used.



**CAUTION:** Risk of electric shock. The back panel and mixing valve contain live circuits. Cut off the electric supply before performing any work. Failure to follow these instructions may result in personal injury or damage to property.



## Back panel

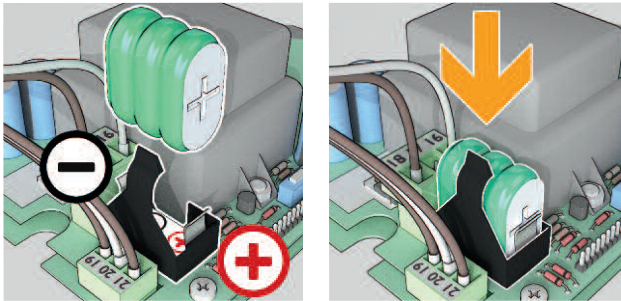
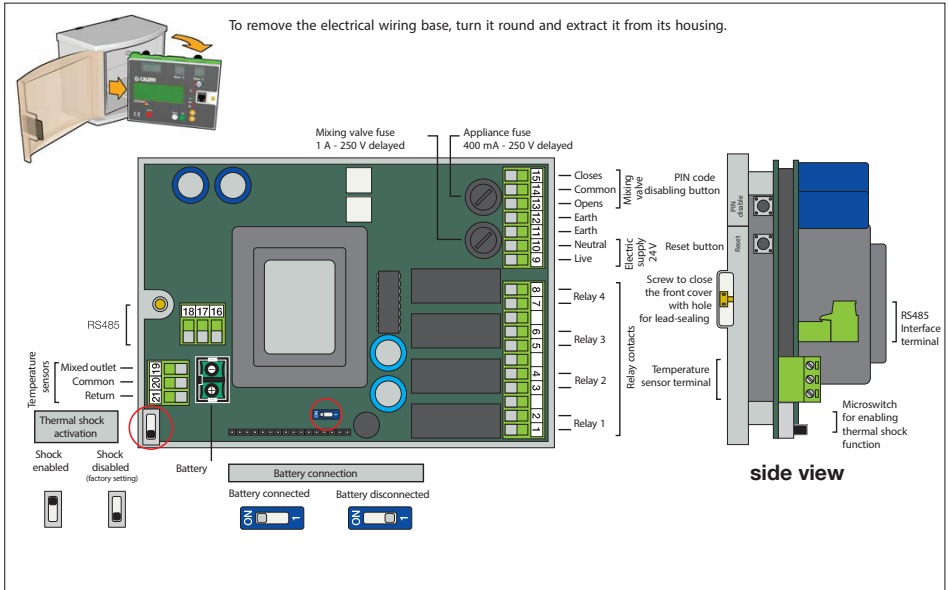

### Connecting temperature sensors:

The cable connecting the mixed temperature outlet and return temperature sensors must be installed in a dedicated raceway. If the connection cable shares the raceway with other live cables, an earthed shielded cable must be used.



In case of reverse polarity or power failure the system enters the **BATTERY ALARM STATUS**, see “Alarms” section.

### Buttons and terminals on side view

The base has two buttons, which can be accessed by opening the front cover:

- Reset button
- PIN code disabling button

## Temperature sensor resistance values

°F	°C	Ω	°F	°C	Ω	°F	°C	Ω	°F	°C	Ω
-5	-20	100254	60	15	15310	130	54	3049	200	93	829
5	-15	72937	70	21	11882	140	60	2489	210	99	702
15	-10	53669	80	27	9297	150	65	2044	220	104	598
25	-4	39919	90	32	7333	160	71	1688	230	110	511
32	0	32648	100	38	5827	170	77	1402	240	115	439
40	4	26100	110	43	4664	180	82	1171	250	121	378
50	10	19900	120	49	3758	190	88	983			

## Location of cable connectors

When making the electrical connections, follow this sequence for wiring the terminal strip and tightening the seals:

1. Power supply
2. Mixing valve control
3. Mixed outlet temperature sensor
4. Return temperature sensor
5. RS485
6. Relay 3
7. Relay 1
8. Relay 4
9. Relay 2

Strain relief cord connectors (white) are provided for all 9 controller housing holes. Clear plastic plugs also provided for unused holes.

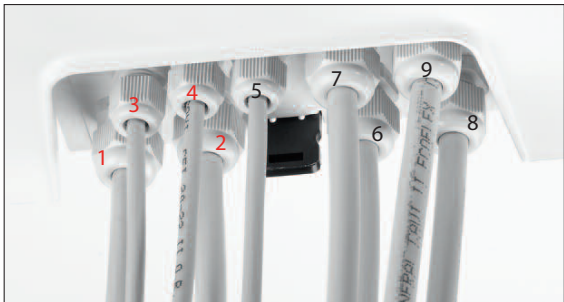

## Enabling functions- Dipswitch settings

- Thermal Shock enable/disable.
- Internal battery (do this during installation)

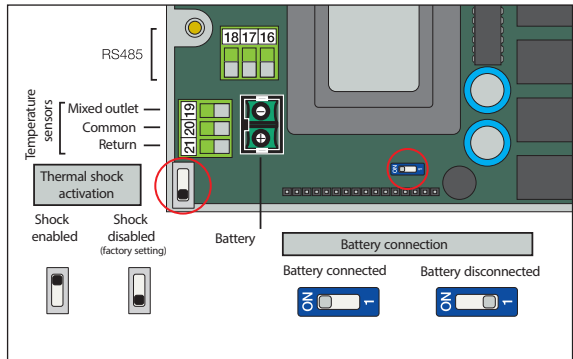

**ATTENTION:** If the battery is not activated the battery alarm will be displayed.

## CAUTION!

The controller is configured to automatically execute a daily rotation cycle to ensure efficient ball operation and cleaning. This occurs directly after the disinfection program, if active, or after 24 hours have elapsed if disinfection is not active. Deactive this function through the ANTI-CLOG setting by entering the release code 5566 and confirming with ON-OFF. Eliminating this function increases the risk of deposits forming on moving parts of valve. If it is necessary to eliminate the disinfection function as well, proceed as follows:

1. disable the ANTI-CLOG function; 2. eliminate the disinfection function.

### Connection cable cross-sections and lengths for circuit board wiring

Cable seal No.	Cable type	Unsheathing (in/mm) including stripping (L)
1	3 x AWG 16	5 / 130
2	6 x AWG 18	6 / 150
3	2 x AWG 18	8.25 / 210
4	2 x AWG 18	8.25 / 210
5	3 x AWG 18	8.25 / 210
6	2 x AWG 16	6.25 / 160
7	2 x AWG 16	6.25 / 160
8	2 x AWG 16	7 / 180
9	2 x AWG 16	6.25 / 160

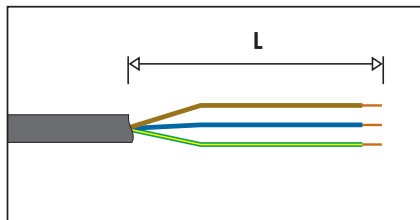

**Connection layout: connections must not create thrust stresses on the circuit board**

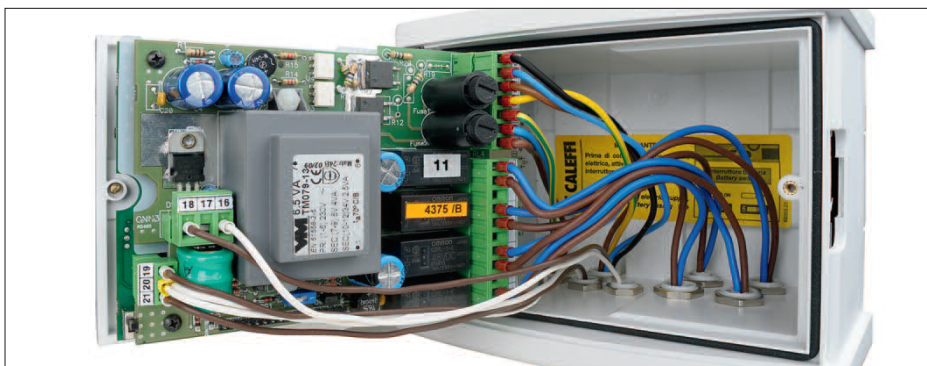

## Front panel

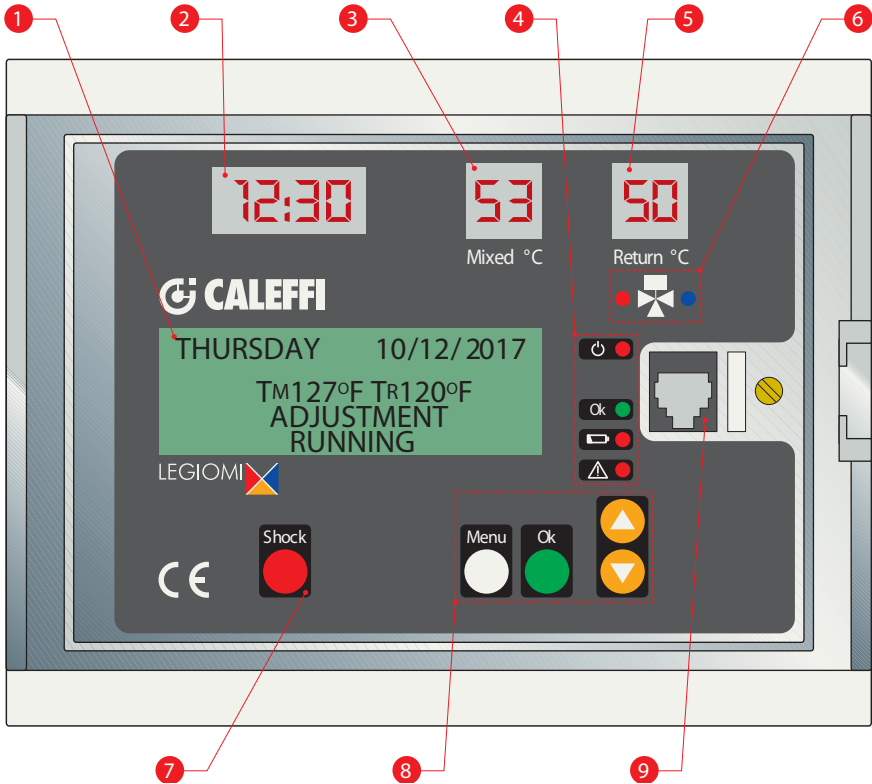

Cut the wires of the auxiliary microswitch (if not used) and insulate electrically before wiring (colors: white, green and red).

1. LCD display\*
2. LED display: Time
3. LED display: Tmixed- Mixed Outlet water temperature (°C only)
4. LED indicator

-  ON
- Status OK
- Battery
- Alarm

5. LED display: Treturn - return water (recirculation) temperature (°C only)
6. Mixing valve open/close LED
7. Thermal shock button
8. Navigation buttons

- Menu
- OK
-  UP
-  DOWN

9. RS 485 front connection

\*Tmixed and Treturn is displayed, default °F. Can be changed to °C in settings (Cels.-Fahr.)

## Indication description

### Indications on LED display

3 LED displays on the front of the controller show the clock time and temperature of the mixed outlet water temperature and return temperature sensors at all times.



Time  
(24 hr clock)



Mixed  
Outlet (°C)



Return  
(Recirc) (°C)

The default setting for the temperatures is OFF because the default temperature units are °F. If the units are changed to °C, in the configuration menu, these LEDs will read in °C. Also, if the recirculation sensor has been set as “not present” in SETTINGS, or is faulty in program 0, the related display remains OFF. Temperatures are in °C only, and can not be changed to °F.



Hour and minutes display  
(24 hour system)



Sensor temperature  
display (in °C)  
Resolution 1 °C



Sensor warning display  
“out of range” at top.  
(blinking)



Sensor warning display  
“out of range” at bottom.  
(blinking)



Sensor warning display  
“open”. (blinking)



Sensor warning display  
“short circuit”. (blinking)

### LED indicators

The following LED indicators are located on the front of the controller:



Electric power supply LED:  
red LED: steadily ON when  
voltage is present.



Mixing valve LED:  
**-red LED:** on when opening  
hot water.  
**-blue LED:** on when opening  
cold water.



Controller OK status LED: green  
LED: steady ON when there are  
no faults or active alarms.



Faulty battery LED:  
red LED: on steady there is a  
battery fault; otherwise it is Off.



Generic Alarm LED:  
red LED: steadily ON when there  
is an alarm (sensor fault, thermal  
shock in progress, reset).

### LCD indicators

Green backlit alphanumeric displays with 4 rows of 20 characters each, for setting parameters, scheduling operations, displaying error messages and machine status are on the front of the controller. Buttons on the front panel (“MENU”, “UP”, “DOWN”, and “OK”) can be used to scroll through the menu items to configure the controller, set various parameters and view the temperature log.

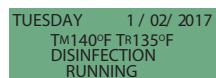
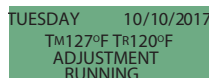

## Operating status

Depending on the times and the programs that have been set, the controller may be in one of the following operating modes.:

- **Adjustment;**
- **Disinfection;**
- **Flushing;**
- **Thermal shock** (this function has #1 priority over other modes)

In the event of trouble due to the LEGIOMIX or the system, the device manages and reports the alarm and, depending on the situation, may maintain operation or not. Accordingly, a distinction is made between the following:

- Active with alarm
- Inactive with alarm

The LEGIOMIX is equipped with a rechargeable battery that keeps the clock working and maintains selected programmed settings during loss of power. In the event of blackout, to ensure the longest battery life, the controller assumes the status:

- Inactive on Low Power

## Adjustment (modulation)- default mode

LEGIOMIX measures the temperature of the mixed water at the valve outlet with temperature sensor and adjusts (modulates) the mixing valve position to maintain the desired set temperature.

## Disinfection

LEGIOMIX runs the disinfection phase, which consists of raising the water temperature to a pre-set value for a specific time duration, by operating the mixing valve as required.

Using the menu, set the days of the week for the disinfection phase to run.

At the end of disinfection, statistical data relating to the just concluded disinfection are logged. This mode begins and ends automatically at a start time (Time ON) and end time (Time OFF) that can be selected by the user in SETTINGS.

**Safety measures must be in place before engaging disinfection mode. Anti-scald protection devices, certified to ASSE 1016 or ASSE 1070, at all downstream fixtures,**

### CONFIRMING DISINFECTION

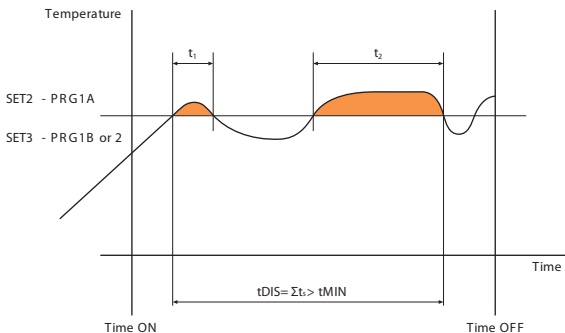

NOTE: Graph is for reference only, not shown on display or logged data.

## Confirming disinfection

If, within the time span (Time OFF - Time ON), the actual disinfection time reaches  $t_{DIS}$  is greater than the set  $t_{MIN}$ , the disinfection is concluded with a positive outcome. It automatically exits this status and returns to the adjustment (modulating) mode.

If the sufficient time  $t_{DIS}$  is not reached, the disinfection phase ends at Time OFF.

## Flushing

LEGIOMIX automatically enters this mode at the end of the disinfection phase, and is used to make the water temperature return to the adjustment value (SET1 value) quicker, or to periodically clear (or flush) the storage of impurities. This phase is ended after a time selected with the  $t_{FLUX}$  parameter. When flushing time has ended, relay 1, relay 4, and the controller returns to the “adjustment” mode.

## Thermal shock

LEGIOMIX adjusts the mixed outlet water temperature at the set shock value (SETSH) for a selected time duration ( $t_{SH}$ ). The Shock button on the front of the controller can be used then to initiate thermal disinfection, the manual mode. This function is associated with activation of alarm 4 (AL4), and illumination of the alarm LED. Thermal shock can be started by pressing the specific button on the front panel (press and hold for at least 5 seconds) while the operating screen is displayed, or to program it with the menu item for a delayed execution (countdown in minutes), or by remote control.

**Thermal shock operation can be stopped, if needed, by pressing the shock button and confirming with the “OK” button, or by remote control.**

This is a potentially dangerous function so a jumper is provided on the printed circuit board to enable it. If the jumper is closed, the Shock function can be used; if it is open, it is not available (see Back Panel section).

At the end of the Thermal shock phase, the controller reverts to the “adjustment” (modulating) mode.

## Low power

LEGIOMIX goes into low power mode with loss of power, and continues to run the internal date clock. NOTE: in this condition there is no power for switching relays, so the controller does not perform the adjustment or disinfection functions, sensor temperatures can not be acquired, and no communication functionality is available. The mixing valve remains in the last state when power went out. LCD and LED displays are off, all LEDs are off, except the “alarm” LED, which will be flashing.

When the power comes back on, the blackout is recorded in the log (alarm AL5) and the controller returns to operating mode as programmed, unless the power failure lasts long enough to completely run down the battery. In this case, LEGIOMIX will be reset to default values when the power is restored.

In the event of a reset or extended power failure, factory settings are restored. If modifying the factory settings, make a copy of the new settings.

## ANTI-CLOG function

The LEGIOMIX controller is configured to execute a daily ball rotation cycle, to ensure efficient ball operation and cleaning. This occurs after the disinfection program concludes, if active, or in any case after 24 hours has elapsed when disinfection is not active. The ANTI-CLOG function can be deactivated through the ANTI-CLOG step in the “SETTINGS” menu by entering the release code 5566 and confirming with ON-OFF. Eliminating this function increases the risk of deposits forming on the moving parts of the valve.

If it is necessary to also eliminate the disinfection function, proceed in the following order: 1. eliminate the ANTI-CLOG function, then 2. eliminate the disinfection function.

## Reset

On the back panel, there is a specific reset button, in case it is necessary to restore the initial settings.



**If the date and time are not set after the reset, the controller will operate according to the factory default settings.**

## Actuation relays

The circuit board and terminals show the relay contacts used to manage auxiliary equipment and to report alarms.

- Relay 1: Circulation pump (**active during disinfection**) Connect Relay 1 in parallel to time clock or aquastat contacts (whatever switch is controlling recirculation pump).
- Relay 2: Generic alarm (sensor fault, battery fault, blackout or clock failure).
- Relay 3: Second thermostat. Wire in parallel to High Temperature thermostat. Use to increase hot water supply temperature for thermal disinfection.
- Relay 4: flushing valves

## Summary of actuation relay status

Operating Status	Adjustment	Disinfection	Flushing	Thermal shock
Relay	Contact status	Contact status	Contact status	Contact status
Relay 1: recirc pump	Open	Closed	Closed	Closed
Relay 2: generic alarm	Open	Open	Open	Closed
Relay 3: second thermostat	Open	Close	Open	Closed
Relay 4: flush valves	Open	Open	Closed	Open

Wiring diagram of relay 1 with a clock for managing the recirculation pump times.

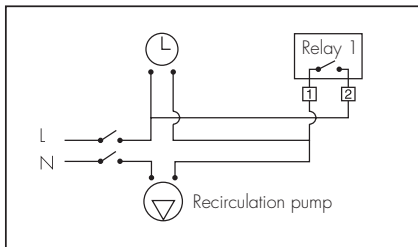

Wiring diagram of relay 3 for connecting the second thermostat on hot water storage.

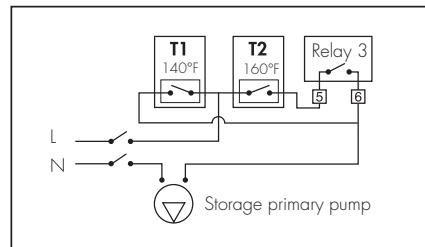



## Programs

The operation of the controller during disinfection can be set according to different programs, selected depending on the type of system and management of the system. Set the program, and the day and time to turn on and turn off disinfection, in parameters in SETTINGS.

### Program 0

Features continuous mixed outlet water temperature modulation with automatic disinfection in a time band that can be set. Disinfection will run only when the Program Day (ProgDay) parameter has days selected (default is no days) and the TimeOn and TimeOff parameters are filled in (default is 00:00 for both). The return water temperature sensor is not used, but if present, it is used as a monitor only. During the disinfection phase, the mixed outlet water temperature must remain above SET2 for a time tDIS at least equal to tMIN, and if this occurs then disinfection has been successful. When this happens, disinfection then stops. If disinfection is not successful, there is no alarm signal. If alarm indication for unsuccessful disinfection is desired, use other programs.

### Program 1A

Features continuous mixed outlet water temperature modulation with automatic disinfection in a time band that can be set. Disinfection will run only when the Program Day (ProgDay) parameter has days selected (default is no days) and the TimeOn and TimeOff parameters are filled in (default is 00:00 for both). The return water temperature sensor is not used, but if present, it is used as a monitor only. During the disinfection phase, the mixed outlet water temperature must remain above SET2 for a time tDIS at least equal to tMIN, and if this occurs then disinfection has been successful. When this happens, disinfection then stops. If the disinfection temperature is not reached or it cannot be maintained for a sufficient period of time, the alarm for unsuccessful disinfection is generated. The alarm is recorded in the log. The first time a button is pressed, the relay opens again. The other alarm indications are cleared at the next successful disinfection.

### Program 1B

This program can only be set if the return water temperature sensor is set at present. Identical to the previous program (1A), the only difference is the successful outcome of the disinfection phase is checked via the return water temperature sensor in relation to SET3 instead of via the mixed outlet water temperature sensor in relation to SET2. As soon as conditions indicate successful disinfection, disinfection then stops. If the disinfection temperature is not reached or it cannot be maintained for a sufficient period of time, the alarm for unsuccessful disinfection is generated. The alarm is recorded in the log. The first time a button is pressed, the relay opens again. The other alarm indications are cleared at the next successful disinfection.

### Program 2 (factory settings - default)

This program can only be set if the return water temperature sensor is used. By default, the disinfection is not enabled (no days are selected). If days are selected during commissioning, it is identical to the previous program (1B). The only difference is, if the return water temperature does not reach SET3 after a wait period (tWAIT) since the start of disinfection, the mixed outlet water temperature SET2 is increased by a value equal to (SET3 - TR reached), considering that SET2 can not in any case exceed the limit of SETMAX. This correction procedure (increasing only) of the disinfection SET is iterative: if necessary, it is repeated in the time span defined by the TimeOn and TimeOff at each time interval equal to tWAIT. As soon as conditions indicate successful disinfection, disinfection then stops. If the disinfection temperature is not reached or it cannot be maintained for a sufficient period of time, the alarm for unsuccessful disinfection is generated. The alarm is recorded in the log. The first time a button is pressed, the relay opens again. The other alarm indications are cleared at the next successful

## Thermal disinfection

The temperatures and corresponding disinfection times for the network must be chosen according to the type of system and the related intended use. The following criteria is generally followed, guided by.....

T = 160° F (70° C) for 10 minutes

T = 150° F (65° C) for 15 minutes

T = 140° F (60° C) for 30 minutes

Thermal disinfection is generally performed during times of reduced system usage, ie: nighttime. This minimizes the potential for scald conditions to occur. Thermal disinfection is recommended to be run every day and at least once per week.

**Safety measures must be in place before engaging disinfection mode. Anti-scald protection devices, certified to ASSE 1016 or ASSE 1070, at all downstream fixtures, must be installed.**

## Interrupting disinfection

**Disinfection can be interrupted while it is still in progress.** On the working screen (showing the message “disinfection in progress”), press the OK button once. The display shows the message “Cancel disinfection?”; and at this point, the OK button can be pressed to stop the disinfection phase and return to the adjustment function (without going through the flush phase). If the OK button is not pressed, after a timeout of about 3 seconds, the display goes back to displaying the message “disinfection running”.

**Table of thermal disinfection programs**

Program # >	0	1A	1B	1B	2
<b>type of confirmation</b>	Adjustment and simple disinfection without confirming	Adjustment and disinfection confirming on the mixed outlet water temperature	Adjustment and disinfection check on return temperature to the central heating system	Continuous disinfection (max. 4 hours)	Adjustment only (default). If scheduled, disinfection confirming.
<b>Use of return sensor</b>	NO	NO	YES	YES	YES
<b>Return sensor shown on LED display</b>	As monitor only	As monitor only	YES	YES	YES
<b>Adjustment temperature</b>	Flow*: (SET1) 68 - 185° F	Flow*: (SET1) 68 - 185° F	Flow*: (SET1) 68 - 185° F	--	Flow*: (SET1) 68 - 185° F
<b>Disinfection temperature</b>	Flow*: (SET2) 104 - 185° F	Flow*: (SET2) 104 - 185° F	Recirculation: (SET3) 104 - 185° F	Recirculation: (SET3) 104 - 185° F - 24 hours	Recirculation: (SET3) 104 - 185° F - with adjustment of flow* up to the max value
<b>Alarm if disinfection unsuccessful</b>	NONE	YES	YES	YES	YES
<b>Recording in log if disinfection unsuccessful</b>	NONE	YES	YES	YES	YES

\*mixed outlet water temperature

## Entering programs and settings

Controller operation is based on an internal clock with calendar and automatic time adjustment. By navigating through the appropriate menu items and using the buttons on the front panel (“MENU”, “UP” ▲, “DOWN” ▼, and “OK”), the user can configure the controller, set the various parameters, and display the temperature log.

## Functions of the configuration buttons

Description	Display	Button function	Effect
Menu item - arrows beside the row		“UP” ▲, “DOWN” ▼	Moves the cursor to another row
		+OK	Opens the related submenu
		Menu	Go back to previous level
Other rows available -arrows in the screen margin		“UP” ▲, “DOWN” ▼	Displays other rows in the menu
Parameter selection -cursor flashing	▶ ☀ ◀	“UP” ▲, “DOWN” ▼	Increases or decreases the parameter value
		+OK	Confirms the setting - cursor disappears and the value becomes actual
		Menu	Return to previous level without making changes

Whatever status the controller is in (except Low Power), navigation around the various menus to read the various settings and view the stored log data is always possible. However, for safety purposes, **the settings data can be modified only when the controller is in “Adjustment” mode.** In particular, parameters can not be modified while the controller is in “disinfection”, “flux” or “thermal shock” mode, and when the controller is in the “inactive with alarm” status. The various options are made available, depending on whether the return water temperature sensor has been enabled. To set programs 1B or 2, the return water temperature sensor must be set as Present. To be able to remove the return water temperature sensor (i.e. set it as Present of Absent), program 0 or 1A must be set first.

## Remote control

The controller can be controlled from a remote computer with the RS485 serial output connection, which can be accessed by hard-wired terminals and through the connector on the front panel. Since the interface is the multipoint bus type it is necessary for each controller connected on the bus to be identified by an appropriate address to avoid identification conflicts. For a detailed description of the operations and controls that are available from a remote location using this interface, refer to the relevant documentation.

Contact Caleffi for list of registers (points) for mapping LEGIOMIX information to ModBus. Configuration, mapping, hardware (routers, modem, etc.), and software are customer/user responsibility. Code NA10520 Modbus-to-BACnet gateway is available separately for translating ModBus to BACnet.

## Operating parameters

The operating parameters can be set in the appropriate menus, and are summarized below:

### Summary of parameters. Setting ranges and factory (default) configuration.

Parameter	Description	Setting Range	Factory (default) configuration
Language	Language shown on LCD display	I-E-F-D-ES-P-NL-SL-HR-SR-RO	ENGLISH
Date/Time	For Disinfection phase and log entries	MM/DD/YY	01/01/2005
Time change	Daylight saving time setting	USA CUS. NO EUR	USA

## Settings

Parameter	Description	Setting Range	Factory (default) configuration
LEGIOMIX "BUS ID"	Number that identifies this appliance (device) among those connected to the BUS.	0 to 255	001
SET_MAX	Sets the max temperature limit: to protect the system. None of the SET values can exceed SET MAX.	122 - 194°F 50 - 90°C	149°F
SET1	Setpoint for Ta (mixed outlet temperature) during adjustment phase.	68 - 185°F 20 - 85°C	113°F
SET2	Setpoint for Ta (mixed outlet temperature) during disinfection phase.	104 - 185°F 40 - 85°C	140°F
SET3	Setpoint for Ta (return temperature) during disinfection phase, for programs 1B or 2.	104 - 185°F 40 - 85°C	135°F
Return sensor present (Rec probe)	The return sensor is analog (NTC).	NO=absent YES=present	YES
PGM program	To modify the working parameters for the disinfection phase.	PRGM 0=0 PRGM 1A=1A PRGM=1B=2B PRGM 2=2	2
ProgDay	Disinfection is conducted on the selected days. Day 1 is Monday.	1 2 3 4 5 6 7 or <u>BLANK</u> for each digit to disable disinfection	No days selected
TIME ON	Start time for the programmed disinfection.	HHMM 0000-2359	0200
TIME OFF	End time for the programmed disinfection.	HHMM 0000-2359	0300
tWAIT	Represents the time considered necessary for the system to bring the return water to a temperature above SET3.	1 to 255 min	002 min
tMIN	The minimum time for the temperature measured by the mixed outlet water temperature sensor (program 1A) or the return water temperature sensor (programs 1B or 2) must remain above the disinfection setpoint so that disinfection will be completed successfully.	0 to 254 min (max 4 hour 14 min)	030 min
tFLUX	Duration of the flushing phase that will start automatically when a disinfection phase is completed.	from 0 to 2550 sec in 10 sec steps	000 sec

Parameter	Description	Setting Range	Factory (default) configuration
tPLAY	Delay due to gap in mechanical components during actuator movement, until the internal valve ball starts to move in the opposite direction.	from 0 to 255 sec in 1 sec steps	005 sec
tMOTOR	Time required for the actuator to move the valve from the full closed to the fully open position. Default setting is recommended for all applications, do not change. Consult Caleffi otherwise. (This is NOT motor stroke time)	from 8 to 320 sec in 2 sec steps	100 sec
ANTI-CLOG	Ball rotation cycle to clean deposit formation for efficient operation. To deactivate enter release code 5566 and confirm with ON-OFF.	ON OFF	ON
Cels.-Fahr.	Temperature units.	°F °C	°F

### Thermal shock

Parameter	Description	Setting Range	Factory (default) configuration
SETSH	Setpoint for Ta (mixed outlet water temperature) during shock phase.	86 - 185°F 30 - 85°C	140°F
tSH	Duration of thermal shock phase to be started manually by the user	1 to 4320 min	005 min
Countdown	Countdown before activating thermal shock	0 to 999 min	0001 min
Activate countdown	Enables activation of countdown before thermal shock	NO= not active YES= active	NONE

### Temperature History

Temperat. History, read only. See Log section, next.

## Log

The “log” is a FIFO (First In - First Out, loop buffer) that is continually updated and records parameters relating to adjustment and disinfection phases that occurred during the day. Data are stored for the last 40 days, after which the data for the first day are overwritten, etc.

The hourly average mixed outlet and return water temperatures are saved to Eeprom every hour, and alarms are saved at the time they occur. The average hourly values of the current day can be viewed at any time. The disinfection data are saved when disinfection ends. The log (via specific menu item) can be viewed on the display or remotely via the RS485 serial interface.

The parameters saved in the log are:

-Date (day, month, year)

-Set program. This is saved when disinfection starts.

-tDIS: actual disinfection time (in steps of minutes).

When the set program is 0 or 1A, this parameter is the time when the temperature of the mixed outlet water was above SET2.

When the set program is 1B or 2, this parameter is the time when the temperature of the return water was above SET3.

This is helpful when it is less than tMIN, to understand how much greater the span of TIME ON: TIME OFF should be to complete the disinfection.

-TRMAX: Max. temperature of the return water sensor during disinfection (if a disinfection was completed that day).

-TRMIN: Min. temperature of the return water sensor during disinfection (if a disinfection was completed that day). It is calculated from the time when the return water sensor measured a value greater than SET3, beginning from the time when the disinfection starts being effective.

-ALARMS AL1, AL2, AL3, AL4, AL5, AL6, AL7 if they were activated on the day in question.

-24 hourly average values of the mixed outlet water temperature.

-24 hourly average values of the return water temperature.

If no disinfection was completed on that day, then the related fields will contain a default value.

If there have been any faults in one or both sensors, the hourly average data will be represented by dashes. If there are any gaps or unavailable data due to a change of date, time, etc., the cells will contain a default value and will be represented on the display by dashes.

## Keyboard Lock (Access PIN code)

**Menu navigation can be prevented by enabling the keypad lock function. The keypad is then unlocked by entering a PIN code. If the lock function is enabled, the keypad is locked automatically after a timeout of 10 minutes starting from the last button press.** When the keypad lock function is active, a padlock symbol appears on the LCD working screen (on the right). 

Also, if the lock function is active and a button is pressed while the working screen is displayed, the PIN code input screen appears: The code is entered by selecting the first digit using the “UP” and “DOWN” buttons, then confirming by pressing OK. The second digit is entered in the same way, etc.

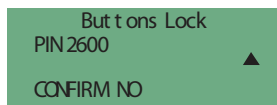
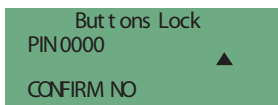
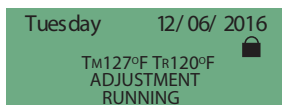

When the last digit is confirmed, if the code is correct, the user can access the menus; if the code is incorrect, the PIN entry screen appears again. If the timeout elapses, the display shows the working screen again.

**If the PIN code is lost or misplaced, the lock function can be overridden (the PIN code is forced to 0000) by pressing a button on the back of the panel (for 5 sec), or by sending a special command through the RS485 interface.**

## Deleting the Log

HISTORIC 06/ 04/ 2005

t DIS 060° PGRM 1A  
TR MAX 130° TR MIN 120°  
ALARM --4-5-7-

HISTORIC 06/ 04/ 2005

H 001 002 003 004  
TM --- --- --- ---  
TR --- --- --- ---

HISTORIC 06/ 04/ 2005

H 007 008 009 010  
TM120 120 120 122  
TR 116 116 116 116

The **log can be completely erased** from the non-volatile memory, using this procedure:

Select the "temperat.history" menu item and press the OK button.

The display shows the data from the first log record available.

Now press and hold the Shock button for at least 1 second.

The display shows a blank screen, which is then gradually filled, indicating that the delete operation is in progress; the LCD display then shows the menu selection screen (higher level), and the log has been completely erased.

If you now go into the log submenu, the only record available will be the one for the present day; note that the temperatures for all hours previous to the present one have also been deleted.

**IMPORTANT: once initiated, the delete operation cannot be cancelled.**

## Battery

The controller has an integrated rechargeable battery (three 140 mAh cells), used to keep the internal clock running and maintain the selected settings even if there is a power failure. While in operation, the battery level of charge is checked periodically (about every 24 hours), and the recharge function is activated if needed. When the battery recharge function is active, the "Btr" icon appears in the working window (in the adjustment mode). 

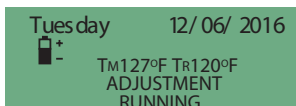

**Battery charging**

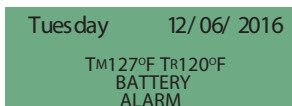

**Battery fault**

If the parameter readings are not within the specified range, the battery is damaged and must be replaced. If a battery fault is detected, the corresponding alarm appears (see the Alarms section): In principle, a battery fault should not affect any of the controller functions, unless there is also a power supply failure.

## Battery replacement

When necessary, replace the battery by removing the depleted battery from its seat and inserting the new battery per the correct polarity placement, shown in the figure.

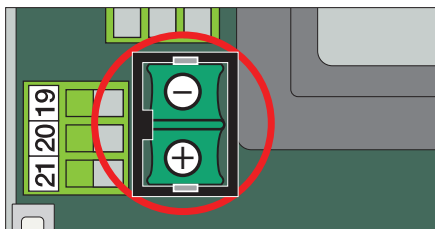

Menu structure table

Level 1	Level 2	Level 3	Button functions
LANGUAGE SEL	LANGUAGE SEL		
	I - E - F - D - ES - P - NL -		▲ UP ▼ DOWN + OK
	SL - HR - SR - RO		
 Confirm the language when turning on the controller. If the language is not selected after 1 minute, the menu goes directly to the date and time selection step. Use the "setting" menu to select language any time.			
DATE/TIME	DATE/TIME		
	DATE <b>01-01-2005</b>	Set: day/month/year	▲ UP ▼ DOWN + OK
	TIME <b>00:00</b>	Set: time	▲ UP ▼ DOWN + OK
	TIME ADJUSTMENT <b>USA</b>	USA - CUS. - NO - EUR	▲ UP ▼ DOWN + OK
SETTING	SETTING		
	Bus ID <b>001</b>	from 0 to 255	▲ UP ▼ DOWN + OK
	SET MAX <b>149°F</b>	122°F to 194°F / 50°C to 90°C	▲ UP ▼ DOWN + OK
	SET1 <b>113°F</b>	68°F to 185°F / 20°C to 85°C	▲ UP ▼ DOWN + OK
	SET2 <b>140°F</b>	104°F to 185°F / 40°C to 85°C	▲ UP ▼ DOWN + OK
	SET3 <b>135°F</b>	104°F to 185°F / 40°C to 85°C	▲ UP ▼ DOWN + OK
	Rec probe <b>YES</b>	NO - YES	▲ UP ▼ DOWN + OK
	PRGM <b>2</b>	0 - 1A - 1B - 2	▲ UP ▼ DOWN + OK
	Prog.day <b>-----</b>	Select day(s) 1 2 3 4 5 6 7	OK
	Time ON <b>02:00</b>	Set time	▲ UP ▼ DOWN + OK
	Time OFF <b>03:00</b>	Set time	▲ UP ▼ DOWN + OK
	tWAIT <b>002'</b>	1 to 255 minutes	▲ UP ▼ DOWN + OK
	tMIN <b>030'</b>	0 to 254 minutes	▲ UP ▼ DOWN + OK
	tFLUX <b>0000'</b>	from 0 to 2550 seconds	▲ UP ▼ DOWN + OK
	tPLAY <b>005'</b>	from 1 to 255 seconds	▲ UP ▼ DOWN + OK
	tMOTOR <b>100'</b>	8 to 320 seconds	▲ UP ▼ DOWN + OK
	ANTICLOG <b>ON</b>	ON - OFF (see instruct. page14)	▲ UP ▼ DOWN + OK
THERMAL SHOCK	THERMAL SHOCK		
	SETSH <b>140°F</b>	85°F to 185°F / 30°C to 85°C	▲ UP ▼ DOWN + OK
	tSH <b>005'</b>	from 1 to 4320 minutes	▲ UP ▼ DOWN + OK
	COUNTDOWN <b>001'</b>	0 to 999 minutes	▲ UP ▼ DOWN + OK
	ACTIVATE countdown <b>NO</b>	NO - YES	▲ UP ▼ DOWN + OK
HISTORIC	VIEW TEMPERATURE TEMPERATURE		
	MM/DD/YY <b>UP-DOWN</b>	LOG MM/DD/YY (Example)	▲ UP ▼ DOWN + OK
		tDIS <b>060'</b>	
		PRGM <b>2</b>	
		TR MAX <b>136°F</b>	
		TR MIN <b>120°F</b>	
		ALARM <b>1234567</b>	
		h 01 02 03 024	
		TA <b>105 110 95 115</b>	
		TR <b>100 105 90 110</b>	
KEYPAD LOCK	KEYPAD LOCK		
	PIN <b>0000</b>	Select code	▲ UP ▼ DOWN + OK
	ENABLE <b>NO</b>	NO - YES	▲ UP ▼ DOWN + OK



**Operability after alarm (page 1)**

Type of alarm	Program	Indication by alarm LED	Indication by LED display	Display on LCD	Recording in log
AL1: flow probe faulty	0 1A 1B 2	Generic alarm LED comes On and Status OK LED goes Off.	Alarm shown on LED display. ("HI", "LO", "SH", "OP" depending on case).	"Flow probe fault" alarm displayed on LCD.	YES (AL1) Stored in the day log.
Return probe fault	0 1A	The alarm LED remains Off and the "Status OK" LED remains On.	Remains Off if program 0, and "HI", "LO", "SH", "OP" displayed (depending on case) if program is 1A.	NONE	Fault is recorded in the day log.
AL2: return probe fault	1B 2	Generic alarm LED comes On and Status OK LED goes Off.	Alarm shown on LED display. ("HI", "LO", "SH", "OP" depending on case).	"Return probe fault" alarm on LCD (screen alternates with working screen).	YES (AL2) Stored in the day log.
Disinfection not completed	0	The alarm LED remains Off and the "Status OK" LED remains On.	NONE	NONE	NONE
AL3: disinfection not completed	1A 1B 2	"Generic alarm" LED comes On and "Status OK" LED goes Off.	NONE	"Disinfection incomplete" alarm on LCD (screen alternates with the working screen).	YES (AL3) Stored in the day log.
AL4: thermal shock in progress	0 1A 1B 2	Generic alarm comes On (but, if no other faults, the Status OK LED also remains On).	NONE	"Thermal shock in progress" alarm on the LCD display.	YES (AL4) Stored in the day log.
AL5: blackout (mains power failure)	0 1A 1B 2	The indicator LEDs remain Off. Only the generic alarm flashes.	Temperature indicators and clock remain Off. Temperatures are not acquired.	LCD remains Off.	Recording of log data is suspended. YES (AL5) When power is restored it is stored in the log.
AL6: appliance reset	0 1A 1B 2	Generic alarm LED comes On and "OK status" LED Off.	Time display 00 : 00 blinking. Time on the LCD.	Entering screen displayed Date and just set Displaying of 01/01/2005 in the LCD date field.	YES (AL6) Stored in the day log.
AL7: battery damaged	0 1A 1B 2	"OK status" LED goes Off. "BTR FAIL" LED comes On. (The generic alarm LED is not lit).	NONE	"Battery damaged" appears on LCD display (alternating with the working screen).	YES (AL7) Stored in the day log.

## Operability after alarm (page 2)

Relay status	Operating status
Relay 2 closed (if no alarms, the relay is normally open).	In safe mode. Mixing valve closes, i.e. only cold water enters. Adjustment or disinfection or thermal shock is cancelled. <b>All alarm indications are cleared when the cause of the alarm has been removed.</b>
Relay 2 open. The alarm relay does not change status.	All functions are ensured. The return probe, if present, is used as a monitor only, since it does not generate an alarm if faulty.
Relay 2 closed. (if no alarms, the relay is normally open).	No disinfection, but adjustment continues and thermal shock is possible. <b>When the first button is pressed, the relay re-opens; indication remains on the display.</b> <b>In all cases, all alarm indications are cleared when the cause of the alarm has been removed.</b>
Relay 2 open. The alarm relay does not change status.	Disinfection failure does not generate any alarms.
Relay 2 closed. (if no alarms, the relay is normally open).	<b>When the first button is pressed, the relay re-opens; indication remains on the display.</b> <b>In all cases, all alarm indications are cleared when the cause of the alarm has been removed, in this case when the next disinfection is successfully completed.</b>  <b>Note: if program 0 is set, any unresolved alarm indication due to incomplete disinfection is cleared.</b>
Relay 2 closed. (if no alarms, the relay is normally open).	Alarms generated. The thermal shock function is potentially dangerous for users of the system. <b>When the first button is pressed, the relay re-opens; indication remains on the display.</b> <b>In all cases, all alarm indications are cleared when the cause of the alarm has been removed, in in this case when the shock function has ended and the appliance begins adjustment again.</b>
Relay 2 closed. (if no alarms, the relay is normally open).	If there is a mains power failure, the back-up battery keeps the appliance's internal clock running. In this situation, all actuations are inhibited (the relays cannot be operated), and therefore all the adjustment, disinfection and thermal shock programs. In this status, the appliance goes into Low Power mode in order to ensure maximum autonomy. The RS485 interface is not available. <b>When power is restored, the blackout alarm (AL5) is stored in the log, and the appliance resumes operation as defined in the programs; there are no alarm indications.</b> <b>However, if the mains power failure lasts long enough for the battery to become discharged, there is a general reset when power is restored.</b>
No relay action.	The printed circuit board has a button for hardware reset of the appliance. This button cannot be operated from the front panel, but only by opening the door of the appliance and accessing the printed circuit board. If the appliance is reset accidentally, or intentionally by pressing the special hidden button, or by interference (lightning, etc.), the correct time and date settings are lost. Settings made by the user are also lost and the factory values are reloaded for all parameters and settings. Therefore, until the correct date and time are re-entered: Appliance remains active in adjustment mode. Disinfection is inhibited. Thermal shock program is inhibited (but thermal shock can still be forced manually or remotely). <b>When the current date and time have been set (manually or remotely), the device comes out of the alarm condition and resumes normal operation. All alarm indications are cleared.</b>
Relay 2 open. The alarm relay does not change status.	While in operation, the level of charge in the battery is checked periodically (about every 24 h), and the recharge function is activated if necessary. If the parameter readings are not within the specified range, it means the battery is damaged and must be replaced. <b>However, the appliance continues performing the specified programs, since a battery fault does not affect any of the appliance functions (unless there is a blackout).</b>  <b>NOTE: for the battery replacement operation refer to the procedure described on page 20.</b>

# MODBUS Registers LEGIOMIX®

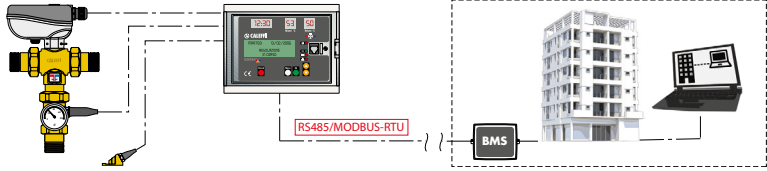

REG	REG (hex)	DESCRIPTION	VALUE	FUNCTION 0x03   0x06
0	0000	Product type Code to define the product	6001	x
1	0001	BUS address	1...247	x
2	0002	T mix	(°C)	x
3	0003	T rec	(°C)	x
4	0004	T mix	(°F)	x
5	0005	T rec	(°F)	x
6	0006	STATUS	0= - 1= regulation 2= disinfection 3= flushing 4= thermal shock 5= alarm	x
7	0007	PROGRAM	0= Program 0 1= Program 1A 2= Program 1B 3= Program 2	x x
8	0008	DAY	1...31	x x
9	0009	MONTH	1...12	x x
10	000A	YEAR	2017...	x x
11	000B	HOUR	0...23	x x
12	000C	MINUTE	0...59	x x
13	000D	LANGUAGE	0=IT 1=EN 2=FR 3=DE 4=ES 5=P 6=NL 7=SL 8=HR 9=SR 10=RO	x x
14	000E	TIME ON - h (Disinfection start hour)	0...23	x x
15	000F	TIME ON - min (Disinfection start minute)	0...59	x x
16	0010	TIME OFF - h (Disinfection stop hour)	0...23	x x
17	0011	TIME OFF - min (Disinfection stop minute)	0...59	x x
18	0012	TIME wait (time reading recirc. Temp.)	1...255 (min)	x x
19	0013	TIME min (MINIMUM DISINFECTION TIME)	0...254 (min)	x x
20	0014	TIME flux (after ending the disinfection)	0...2550 (sec)	x x
21	0015	TIME shock (time of duration shock)	1...4320 (min)	x x
22	0016	SET REG - mixing regulation set temperature	20...85 (°C)	x x
23	0017	SET DIS - disinfection set temperature	40...85 (°C)	x x
24	0018	SET REC - recirculation set temperature	40...85 (°C)	x x
25	0019	SET SHOCK - shock set temperature	30...85 (°C)	x x
26	001A	SET Tmax - Maximum limit of range set temperature	50...90 (°C)	x x
27	001B	SET REG - mixing regulation set temperature	68...185 (°F)	x x
28	001C	SET DIS - disinfection set temperature	104...185 (°F)	x x
29	001D	SET REC - recirculation set temperature	104...185 (°F)	x x
30	001E	SET SHOCK - shock set temperature	86...185 (°F)	x x
31	001F	SET Tmax - Maximum limit of range set temperature	122...194 (°F)	x x
32	0020	Daily disinfection	0= Monday 1= Tuesday 2= Wednesday 3= Thursday 4= Friday 5= Saturday 6= Sunday	x x

REG	REG (hex)	DESCRIPTION	VALUE				FUNCTION	
			b0:1 b3:0 = Legal hour EU	b2:0 b3:1 = Legal hour US	b2:1 b3:1 = Legal hour CUST	0x03	0x06	
33	0021	Active functions	b0: Presence of recirc. probe b1: Anticlog b2:0 b3:0 = Legal hour OFF - b4: Internal System of Unit b5: LED display enable				x	x
34	0022	Forced activities	0= Shock activation 1= Pin-code reset 2= Disinfection reset 3= Alarm reset 4= Historical data reset					x
35	0023	TIME motor - from close to full open	8...320 (sec)				x	x
36	0024	TIME play - delay of time of actuator	1...255 (sec)				x	x
37	0025	START Sunday legal hour	-3...3				x	x
38	0026	START Month legal hour	1...12				x	x
39	0027	END Sunday legal hour	-3...3				x	x
40	0028	END Month legal hour	1...12				x	x

**MODBUS functions:**

Function 0x03 - Read Holding Registers

Used to read one or more parameters (the size of every parameter is 16 bit)

The frame has the following structure:

dev. Addr.	func	start addr H	start addr L	N.regs H	N.regs L	CRC16H	CRC16L
HH	03	HH	HH	00	00	HH	HH

dev. Addr. - Address of the device on the RS485 net (1-247)

Func - Function code = 3

start addr H - MSByte of the address of the parameter;

start addr L - LSByte of the address of the parameter

N.regs H - MSByte of the number of registers to read (always 0)

N.regs L - LSByte of the number of registers to read

CRC16H - MSByte of CRC16

CRC16L - LSByte of CRC16

If during a multiple reading request, is specified a not allowed quantity of registers, the device will answer with an exception code 0x02 (ILLEGAL DATA ADDRESS).

Function 0x06 - Write Single Register

Used to write a single parameter ( 16 bit )

The frame has the following structure:

dev. Addr.	func	Reg.addr H	Reg.addr L	Reg. val. H	Reg. val. L	CRC16H	CRC16L
HH	06	HH	HH	HH	HH	HH	HH

dev. Addr. - Address of the device on the RS485 net (1-247)

Func - Function code = 6

Reg. addr H - MSByte of the address of the parameter

Reg. addr L - LSByte of the address of the parameter

Reg. val. H - MSByte of the value of the parameter

Reg. val. L - LSByte of the value of the parameter

CRC16H - MSByte of CRC16

CRC16L - LSByte of CRC16

The specified value is not accepted (exception code 2) if it is not consistent with the parameter range or if it is not consistent with the current state of the device (e.g. day = 31 rejected if month = 4, month = 4 rejected if day = 31).

## Plumbing installation

Before installing the LEGIOMIX electronic mixing valve, pipes must be flushed to prevent impurities in the water from affecting performance. Always install strainers of appropriately sized capacity at the inlet from the water main supply. Caleffi LEGIOMIX electronic mixing valves must be installed as shown below, conforming to applicable codes, and installed either vertically or horizontally, but the actuator must never be oriented upside down.

## System piping

Recirculation connections in hot water system should be located as near as possible to the fixtures they serve.

Anti-scald mixing valves should be located at all points of use (i.e. sinks) to provide safe water temperature as specified in local codes or requirements.

All mixing valves should be identified and have their maximum discharge temperature measured and documented on regular basis.

Where a mixing valve is installed within the hot water supply;

- Precaution should be taken to prevent the buildup of high temperature water in piping during periods of low or no use.
- Check valves should be provided to prevent bypassing of hot and cold water through the mixing valve.

The mixing valve body indicates with arrows, hot water inlet - red, cold water inlet - blue.

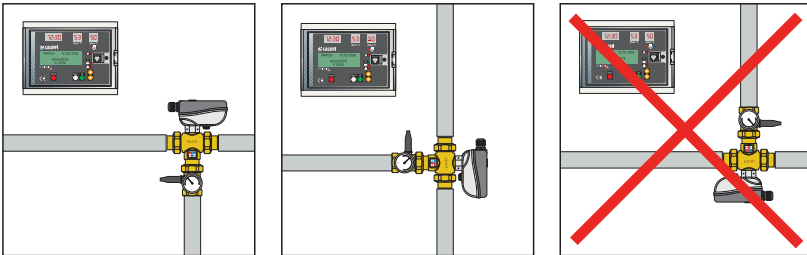

## Check valve

In systems with inlet pressure fluctuations, check valves should be installed to prevent backflows, as is shown in the application diagrams. Check valves, code NA10366 (for 1" and 1¼" LEGIOMIX) and NA10367 (for 1½" and 2" LEGIOMIX) may be used.

## Commissioning

Due to the special purpose for electronic mixing valves, commissioning in accordance with current regulations and by qualified personnel using suitable instruments is required. Check that the hot and cold water supply pressures are within operating limits of the mixing valve, see technical specifications. Check the temperature of the hot water coming from storage, greater than or equal to 140°F (60°C). Record all parameters settings and measurements taken in the installation log book.

## Maintenance

During service, regularly monitor the performance of the LEGIOMIX electronic mixing valve since any loss of performance may indicate maintenance is needed for the valve or the system. If the temperature of the mixed water is found to have changed significantly compared to previous recordings, refer to installation and commissioning sections. The following check points are recommended periodically, at least every 12 months or more frequently, to ensure that the valve continues to deliver optimum levels of performance:

- 1) Check and clean the filters installed in the system.
- 2) Check that any check valve installed at the inlet of the LEGIOMIX electronic mixing valve is functioning correctly, and there are no leaks caused by dirt.
- 3) The internal components of the valve can be descaled by immersing in a suitable descaling fluid.
- 4) Follow commissioning procedure again after maintainable components have been checked.
- 5) Record all operations conducted on system log book.

## Alarm management

To make it easier to resolve any functional faults that occur after installation and commissioning, the controller is configured so that faults are indicated by special alarms and the appropriate action is taken. The cause of the alarm is shown on the LCD display. If the alarm does not inhibit all the functions, the alarm screen will alternate with controller status screen.

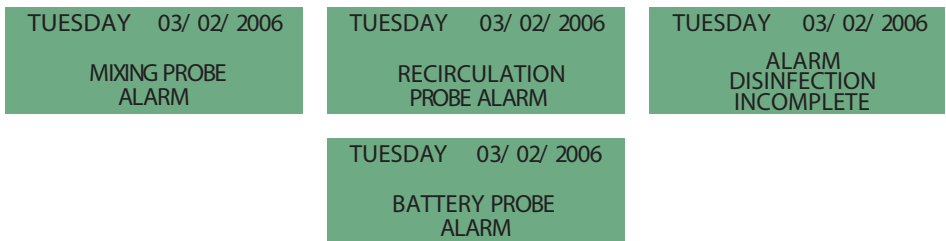

## Alarm description

Alarm indicator	Description
AL1	Mixed outlet water temperature sensor fault
AL2	Return water temperature sensor fault
AL3	Disinfection failed
AL4	Thermal shock in progress
AL5	Main power failure
AL6	Controller reset
AL7	Battery default

Depending on the alarm type, certain actions occur, relay statuses modified and information shown on the LED display, LCD display and LEDs on the front panel.

**Application diagrams**

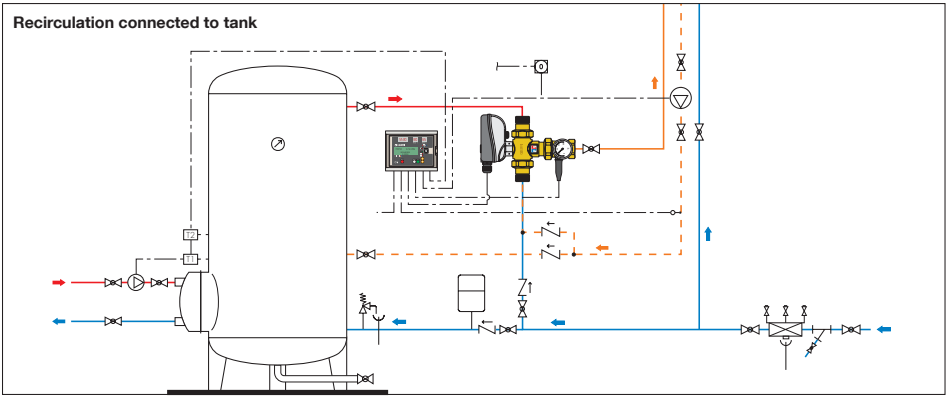
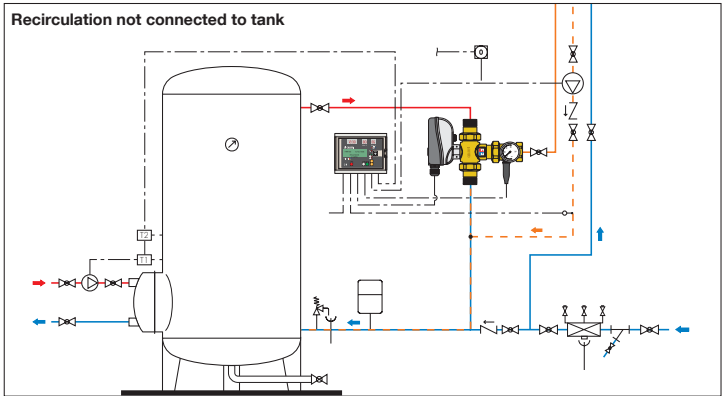
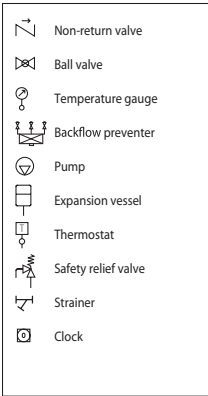

***The following information is provided in accordance with the Electronic Code of Federal Regulations (FCC) PART 15 — RADIO FREQUENCY DEVICES §15.105.***

**§15.105 Information to the user.**

(a) For a Class A digital device or peripheral, the instructions furnished the user shall include the following or similar statement, placed in a prominent location in the text of the manual:

NOTE: This equipment has been tested and found to comply with the limits for a Class A digital device, pursuant to part 15 of the FCC Rules. These limits are designed to provide reasonable protection against harmful interference when the equipment is operated in a commercial environment. This equipment generates, uses, and can radiate radio frequency energy and, if not installed and used in accordance with the instruction manual, may cause harmful interference to radio communications. Operation of this equipment in a residential area is likely to cause harmful interference in which case the user will be required to correct the interference at his own expense.

(b) For a Class B digital device or peripheral, the instructions furnished the user shall include the following or similar statement, placed in a prominent location in the text of the manual:

NOTE: This equipment has been tested and found to comply with the limits for a Class B digital device, pursuant to part 15 of the FCC Rules. These limits are designed to provide reasonable protection against harmful interference in a residential installation. This equipment generates, uses and can radiate radio frequency energy and, if not installed and used in accordance with the instructions, may cause harmful interference to radio communications. However, there is no guarantee that interference will not occur in a particular installation. If this equipment does cause harmful interference to radio or television reception, which can be determined by turning the equipment off and on, the user is encouraged to try to correct the interference by one or more of the following measures:

- Reorient or relocate the receiving antenna.
- Increase the separation between the equipment and receiver.
- Connect the equipment into an outlet on a circuit different from that to which the receiver is connected.
- Consult the dealer or an experienced radio/TV technician for help.

THE LEGIOMIX 6000 SERIES POINT-OF-DISTRIBUTION (ASSE 1017) ELECTRONIC MIXING VALVE IS INTENDED TO BE BUT ONE COMPONENT IN AN OVERALL RISK MANAGEMENT PLAN AS DESCRIBED IN ANSI/ASHRAE STANDARD 188 "LEGIONELLOSIS: RISK MANAGEMENT FOR BUILDING WATER SYSTEMS". WHEN INSTALLED AND USED AS DESIGNED AND INTENDED, THE LEGIOMIX CAN HELP REDUCE BACTERIA IN DOMESTIC HOT WATER RECIRCULATION SYSTEMS, HOWEVER DUE TO SYSTEM-DEPENDENT VARIABLES, 100% ERADICATION CAN NOT BE GUARANTEED. CALEFFI IS NOT RESPONSIBLE FOR ANY DAMAGES, CONSEQUENTIAL OR OTHER, THAT MAY ARISE FROM LEGIONELLA ILLNESS WHEN USING THE LEGIOMIX ELECTRONIC MIXING VALVE.



**Caleffi North America, Inc.**  
**3883 West Milwaukee Road**  
**Milwaukee, WI 53208**  
**T: 414.238.2360 F: 414.238.2366**

8-15-2021