

## Model# 0128-LE6

### Two Handle Cast Brass Kitchen Faucet

#### FEATURES & SPECIFICATIONS

- 2-3/8" Lever Handle
- 8" D Style Swivel Spout
- Replaceable Seats
- 4-Hole 6" Installation
- Side Spray Assembly 1.5 GPM Flow Rate
- 1.5 GPM Flow Rate

#### FINISHES

- PC Polished Chrome

#### STANDARDS

- ASME A112.18.1
- ANSI A117.1 / ADA COMPLIANT



#### FLOW

- 1.5 GPM Flow Rate

#### WARRANTY

- Lifetime Limited Warranty
- Lifetime Residential Warranty
- 5 Year Commercial Warranty

0128-LE6/REV. 11 2016

Product Specifications subject to change without notice

Job Name \_\_\_\_\_ Date \_\_\_\_\_  
Model Specified \_\_\_\_\_ QTY \_\_\_\_\_  
Customer/Wholesaler \_\_\_\_\_  
Contractor \_\_\_\_\_  
Architect/Engineer \_\_\_\_\_  
Submitted as Shown \_\_\_\_\_  
Submitted w/ Variations \_\_\_\_\_

## Model# 0128-LE6

### Two Handle Cast Brass Kitchen Faucet

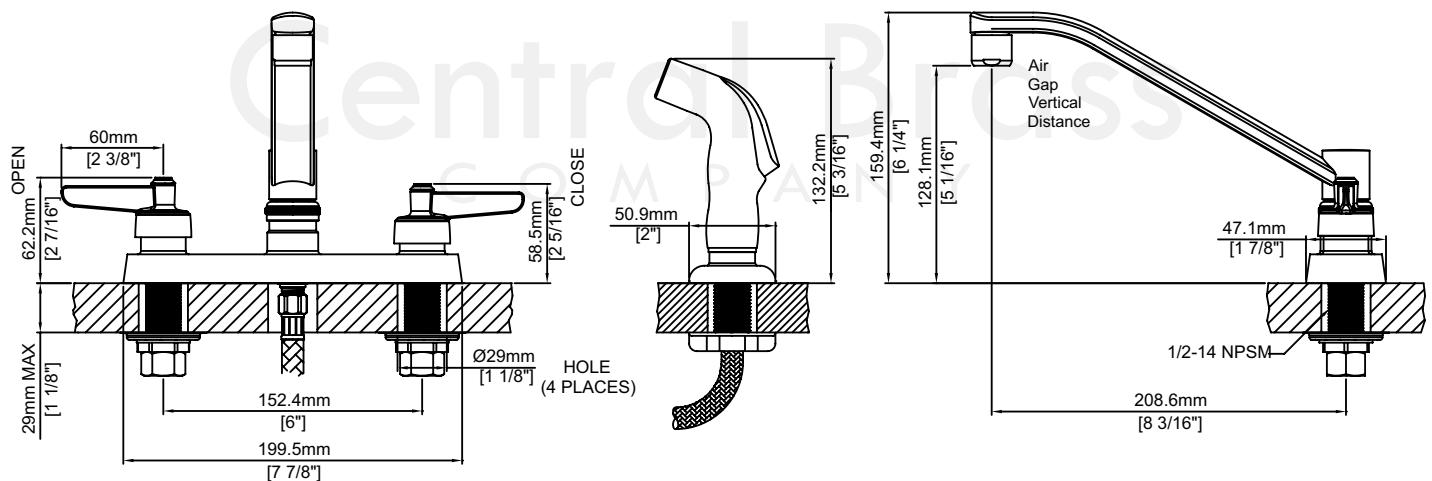

0128-LE6/REV. 11 2016

Product Specifications subject to change without notice