

Soap Dispenser

Finishes : **stainless steel finish** Part no. : **40418800**



Description

Features

- Metal
- 10 oz capacity

Item details

List Price \$ 235.00

Compliance



Product image



Scale drawing

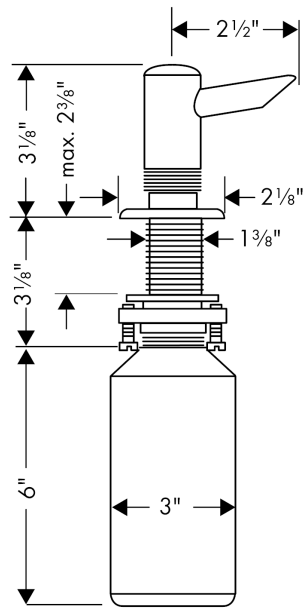

Soap Dispenser

Finishes : **stainless steel finish**

Part no. : **40418800**



Exploded drawing

Year of production: **>04/00**

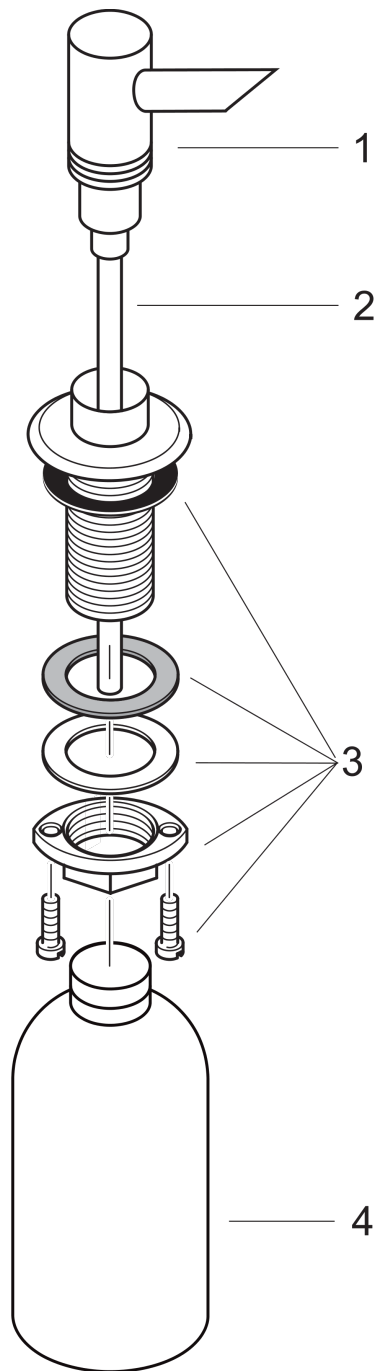

Soap Dispenser

Finishes : **stainless steel finish** Part no. : **40418800**



Spare parts list

Year of production: >04/00

Pos.	Description	Part no.	Price	PU
1	pump	94182800	-	1
2	pipe	97365000	-	1
3	fixing set (Ø 32)	13961000	-	1
4	bottle for lotion dispenser	94418000	-	1